

Operating instructions

Compleo **ADVANCED** bm

Compleo DUO bm/ DUO fleet bm

Article Number: A010C3XX1X



1	About this manual.....	6
1.1	Further requirements	6
1.2	Manufacturer and contact address.....	7
1.3	Conventions of presentation	8
1.4	Abbreviations	9
2	Safety.....	11
2.1	Warnings	11
2.1.1	Sectional warnings	12
2.2	Intended use	12
2.3	Foreseeable misuse.....	12
2.4	Safety instructions for the user.....	13
2.5	Personnel qualification	13
2.6	Dangers and residual risks.....	14
2.6.1	Electrical voltage	14
2.6.2	Incorrect handling.....	14
3	Product description	15
3.1	Design	16
3.2	Series label	17
3.3	Scope of delivery.....	18
3.4	Technical specifications	20
4	Transport, packaging and storage.....	23
4.1	Transport Inspection.....	23
4.2	Storage conditions.....	23
5	Installation.....	24
5.1	Location	24
5.2	Installation work	24
5.3	Mechanical installation.....	25
5.3.1	Base mounted	26
5.3.2	Lateral cable routing through the unit housing	28
5.3.3	Installation on SMC base.....	29
5.3.4	Installation on concrete base	33
5.3.5	Closure of the housing, single and double lock	36
5.4	Electrical installation	37
5.4.1	Power supply cable	38
5.4.2	Equipotential bonding	41
5.5	Data connection cable	43
5.5.1	RJ45 connector	45
6	Commissioning	47
6.1	Testing the charging system	48

6.2	System start-up	48
6.3	Configuration of the charging system with Compleo DUCTO	49
6.3.1	Creating a network connection.....	49
6.3.2	Calling up the configuration interface	51
6.3.3	Operator login.....	51
6.3.4	Changing parameters	52
6.3.5	Log in as electrician	54
6.4	DUCTO Guide.....	58
6.5	Load management	59
7	Operation	60
7.1	Charging process	62
7.1.1	Meaning of the status LED colours	62
7.1.2	Authorisation.....	63
7.1.3	Connecting the charging cable	64
7.1.4	Starting the charging process.....	64
7.1.5	Ending the charging process.....	64
7.1.6	Disconnecting the charging cable.....	65
7.1.7	Retrieve billing data	65
7.2	Operating Signals and Displays	66
8	Error display and measures.....	69
8.1	Error status.....	69
8.1.1	EVCommunicationError (A).....	69
8.1.2	GroundFailure (B)	69
8.1.3	HighTemperature (C).....	70
8.1.4	InternalError (D).....	70
8.1.5	OverVoltage (E)	70
8.1.6	PowerMeterFailure (F)	71
8.1.7	PowerSwitchFailure (G)	71
8.1.8	ReaderFailure (H).....	71
8.1.9	UnderVoltage (I)	71
8.1.10	WeakSignal (J)	72
8.2	Compleo-specific error status.....	73
8.2.1	IsolationWarning (K)	73
8.2.2	IsolationError (L).....	73
8.2.3	DoorOpen (M).....	73
8.2.4	DoorClosed (N)	73
8.2.5	Inoperative (O)	74
8.2.6	FuseError (P)	74
8.2.7	TemperatureSensorMissing (Q)	74
8.2.8	TemperatureSensorHighLimitViolation (R).....	75

8.2.9	TemperatureSensorLowLimitViolation (S)	75
8.2.10	AutomaticRcdTestRunning (T)	75
8.2.11	AutomaticRcdTestFailed (U)	76
8.2.12	RCSensorTestRunning (W)	76
8.2.13	DcPsuConnectionFailure (X)	76
8.2.14	DcInsulationCodeWarning (Y)	77
8.2.15	DcInsulationCodeFault (Z)	77
8.2.16	DcInsulationCodeInvalid (1)	77
8.2.17	DcInsulationTestFailureOnStart (2)	78
8.2.18	DcInsulationTestFailureOnCharge (3)	78
8.2.19	samTransactionMemoryFull (4)	78
8.2.20	samEVSEIDMemoryFull (5)	79
8.2.21	samFirmwareCorrupted (6)	79
8.2.22	samNoTouchControllerComm (7)	80
8.2.23	samNotInitialized (8)	80
8.2.24	samInternalError (9)	80
8.2.25	UnlockPlugFailure (a)	81
8.2.26	OutletCloseError (b)	81
8.2.27	LPCCommunicationError (c)	81
8.2.28	CableError (d)	82
8.2.29	RCSensorTestError (e)	82
8.2.30	PowerMonitoringError (f)	82
8.2.31	ADCErrror (g)	83
8.2.32	ShortCircuitError (h)	83
8.2.33	LPCOverVoltageError (i)	83
8.2.34	LPCHighTemperatureError (j)	84
8.2.35	LPCSelftestError (k)	84
8.3	Error events	85
8.3.1	AutomaticRcdTestResetFailure ()	85
8.3.2	ResetFailure ()	85
8.3.3	AutomaticRcdTestSuccess ()	85
8.3.4	AutomaticRcdTestTripFailure ()	86
8.3.5	AutomaticRcdResetContactorTestFailed ()	86
8.3.6	AutomaticRcdResetSuccess ()	86
8.3.7	AutomaticRcdResetSwitchOnFailed ()	87
8.3.8	AutomaticRcdResetContactorTestFailed ()	87
8.3.9	ConnectorLockFailure ()	87
8.3.10	DriveError ()	88
8.3.11	LastGasp ()	88
8.3.12	McuReset ()	88
8.3.13	OutletOpenError ()	89

8.3.14 OverCurrentFailure ()	89
8.3.15 RCSensorErrorDuringCharge ()	90
8.3.16 RCSensorNoError ()	90
8.3.17 RCSensorTestOk ()	90
8.3.18 RCSensorTestError ().....	91
9 Malfunctions	92
9.1 Internal errors.....	92
9.2 Residual current circuit breaker (RCCB).....	92
9.3 Circuit breaker (MCB).....	92
10 Error display and measures.....	93
10.1 About this advices.....	93
10.1.1 Field of application	93
10.2 OCPP 1.6.....	93
10.3 Compleo-specific	95
11 Maintenance	99
11.1 Maintenance plan.....	100
11.2 Cleaning	101
12 Decommissioning, dismantling and disposal.....	102
12.1 Disposal	102
13 Annexes	103
13.1 Housing dimensions.....	103
13.2 Prüfprotokoll.....	106
13.3 EU Declaration of Conformity	110

1 About this manual

This manual contains descriptions and important information for the safe and trouble-free use of the charging system. The manual is part of the charging system and must be accessible at all times to all persons working on and with the charging system. The manual must be kept in a clearly legible condition.

The personnel must have carefully read and understood this manual before starting any work. The basic prerequisite for safe working is the observance of all specified safety and warning instructions as well as handling instructions in this manual.

In addition to the instructions in this manual, the local accident prevention regulations and the national industrial safety regulations apply.

Illustrations are for basic understanding and may differ from the actual design of the charging system.

1.1 Further requirements

The operator must ensure that the charging system is properly installed and used as intended.

During installation and start-up, the national legal requirements and regulations for accident prevention must be observed. In Germany these include the requirements according to DIN VDE 0100 and the accident prevention regulations according to DGUV V3.

Before the system is released, an appropriate test must be carried out to ensure all safety features and the proper functionality of the charging system. In addition, the operator must ensure the operational safety of the charging system by means of regular maintenance (see chapter).

This document reflects the state-of-the-art of the product at the time of publication.

ATTENTION

A list of the normative references and regulations according to which the charging system was designed and constructed can be found in the declaration of conformity. When installing and commissioning a charging system from Compleo Charging Solutions, nationally applicable standards and regulations must also be observed.

NOTE

All standards, regulations, test intervals and the like mentioned in this document are valid in Germany. If a charging system is set up in another country, equivalent documents with a national reference must be used.

1.2 Manufacturer and contact address

Compleo Charging Solutions AG
Oberste-Wilms-Straße 15a
44309 Dortmund, Germany

Tel.: +49 231 534 923 - 777

Fax: +49 231 534 923 - 790

e-mail address: info@compleo-cs.com

1.3 Conventions of presentation

For easy and quick understanding, different information in this manual is presented or highlighted as follows:

- List without fixed order
- List (next item)
 - Subitem
 - Subitem

- 1. Handling instruction (step) 1
- 2. Handling instruction (step) 2
 - Additional notes for the previous step

- 1 Position number in figures and legends
- 2 Consecutive position number
- 3 ...

- List/check point
- List/next check point

Reference (example): See "chapter 6.5, page 27"

NOTE

A note contains application tips and useful information, but no warnings of hazards.

1.4 Abbreviations

Abbreviation	Explanation
AC	Alternating Current (en: Alternating Current)
AP	Delivery point
CCS	Combined Charging System (de: kombiniertes Ladesystem)
CHA	Abbreviation for plug designation: CHAdeMO
CPO	Charge Point Operator (en: Charge Point Operator)
CRC	Cyclic Redundancy Check (en: Cyclic Redundancy Check)
DC	Direct Current (en: Direct Current)
EMC	Electromagnetic Compatibility
EVSEID	Electric Vehicle Supply Equipment ID (en: Electric Vehicle Supply Equipment ID)
HMI	Human-Machine Interface (en: Human-Machine Interface)
HW	Hardware
HRA	Hardware redundant shutdown
IMD	Insulation monitoring unit
IR	Infrared
kWh	Kilowatt hour
LCD	Liquid Crystal Display (en: Liquid Crystal Display)
LES	Charging device controller
LIEF	Energy supplier
LS	Charging system/charging station
LV	Charging process

Abbreviation	Explanation
MCB	Miniature Circuit Breaker
MessEG	Measuring and calibration law
MessEV	Measuring and calibration regulations
MSB/MDL	Metering point operators/ metering service providers
MSP/ EMSP	(Electric) Mobility Service Provider
OCP	Open Charge Point Protocol
PSU	Power Supply Unit (en: Power Supply Unit)
RCD	Residual Current Device
RTC	Real-Time Clock (en: Real-Time Clock)
S/N	Serial number
SAM	Memory and display module
SML	Communication protocol (en: Smart Message Language)
SVHC	Substances of Very High Concern
SW	Software
VNB	Distribution system operator

2 Safety

In order to ensure operational safety of the charging equipment and to avoid serious injuries caused by flashovers or short circuits, the following information and safety instructions for operating the unit must be observed. Repair work on the unit must only be carried out by authorised specialist personnel. The housing of the unit may only be opened by persons who have been properly instructed. The following points therefore apply:

- Read and observe safety and warning instructions
- Read and follow instructions

2.1 Warnings

In this manual, warnings and notes are presented as follows.

⚠ DANGER

Indicates an imminent danger that will result in death or serious injury if not avoided. There is great danger to life.

⚠ WARNING

Indicates a potentially hazardous situation which, if not avoided, could result in death or serious injury.

⚠ CAUTION

Indicates a potentially hazardous situation which, if not avoided, may result in minor or moderate injury.

ATTENTION

Indicates a potentially hazardous situation which, if not avoided, may result in property damage.

2.1.1 Sectional warnings

Sectional warnings refer to entire chapters, a section or several paragraphs within this manual.

Sectional warnings are presented as follows (example warning):

⚠ WARNING

Type and source of the danger.

Possible consequences if the danger is not observed.

- Measures to avoid the danger.
-

2.2 Intended use

The charging system is intended exclusively for charging electric vehicles.

The charging system is suitable for public and semi-public areas and can be used indoors and outdoors.

The charging system is intended exclusively for stationary installation.

Any use beyond this is considered improper use. The manufacturer is not liable for damages resulting from this.

2.3 Foreseeable misuse

The use of the charging system as a power source for other power consumers is not in accordance with its intended use and is considered misuse.

Only charging cables of type 2/ 20 A or only charging cables of type 2/ 32 A may be used on charging systems equipped with a charging socket type 2. Charging cables that deviate from this are not accepted by the systems.

Charging systems may only be connected to the power supply via a fixed and non-separable supply line.

2.4 Safety instructions for the user

This charging system may only be used in the manner described in this manual. If the charging system is used for other purposes, the operator may be endangered and the charging equipment may be damaged. This manual must always be accessible. Note the following points:

- If no charging process is active, anchor any existing charging cables on the charging system in the brackets provided or wrap them around the housing of the charging system.
- The distance between a charging system and a vehicle must not exceed 3 metres.
- The charging system may only be operated when completely closed. Do not remove covers inside the charging system.

2.5 Personnel qualification

Qualified and trained electricians meet the following requirements:

- Knowledge of general and special safety and accident prevention regulations.
- Knowledge of the relevant electrical engineering regulations.
- Product-specific knowledge through appropriate training.
- Ability to identify hazards associated with electricity.

 DANGER

Danger due to electric current

Touching live parts will result in electric shock with serious injury or death.

- Work on electrical components may only be carried out by a qualified electrician and in accordance with electrical engineering rules.
 - Ensure they are de-energised and take suitable protective measures.
-

2.6 Dangers and residual risks

NOTE

Compleo charging systems as a whole do not contain SVHCs (Substances of Very High Concern) in a concentration of more than 0.1 % (w/w), related to the individual charging station. However, individual components may contain SVHCs in concentrations > 0.1 % (w/w).

- When the charging stations are used as intended, no SVHCs are released and there are no risks to humans or the environment.
-

2.6.1 Electrical voltage

Dangerous electrical voltages may be present inside the housing of the charging system after the housing has been opened. There is a danger to life if contact is made with live components. Serious injury or death is the result.

- Work on electrical equipment may only be carried out by a qualified electrician and in accordance with electrical engineering rules.
- Disconnect the charging system from the power supply.

2.6.2 Incorrect handling

- Pulling on the charging cable can lead to cable breakage and damage. Only pull the charging cable out of the socket directly at the plug.
- The use of extension cables is not permitted. To avoid the risk of electric shock or cable fire, only one charging cable may be used at a time to connect the electric vehicle and charging system.
- A charging system whose charging cables are in contact with the ground involves a risk of tripping or mechanical damage if run over. The operator of the charging system must implement appropriate measures for cable routing and affix appropriate warnings.

3 Product description

The Compleo DUO bm/ Compleo DUO fleet bm (Compleo ADVANCED bm) charging system has the functionality for mode 3 charging. The charging system has two charging points where parallel charging is possible. The type of charger interface can be configured according to customer requirements and is available as a hinged and sliding type 2 socket or as an attached charging cable.

For a "BM" type installation, the charging system is fixed directly to the ground or to a base embedded in the ground. The charging system is offered in different performance classes. Depending on the product class and scope, the charging systems are suitable for use in public and semi-public areas. All charging systems from Compleo Charging Solutions AG can be used indoors and outdoors.

The charging system has a status LED and/or a display embedded in the housing. They show different states, such as an ongoing charging process or status change or the transition from a successful authorisation to the charging process. The meter reading of a charging point can be quickly captured and read from an appropriately recessed window on the housing.

The charging system incorporates state-of-the-art protection technology that ensures maximum safety for the charging system and persons operating it.

3.1 Design



- 1 Cover (roof)
- 2 Display
- 3 Charger interface, socket type 2
- 4 Door with locking mechanism

Fig. 1: Charging system (illustration similar)

3.2 Series label

The charging systems from Compleo Charging Solutions AG can be identified by an individual serial number. There is a series label attached outside and inside the charging system. The following illustration shows an example of a series label:

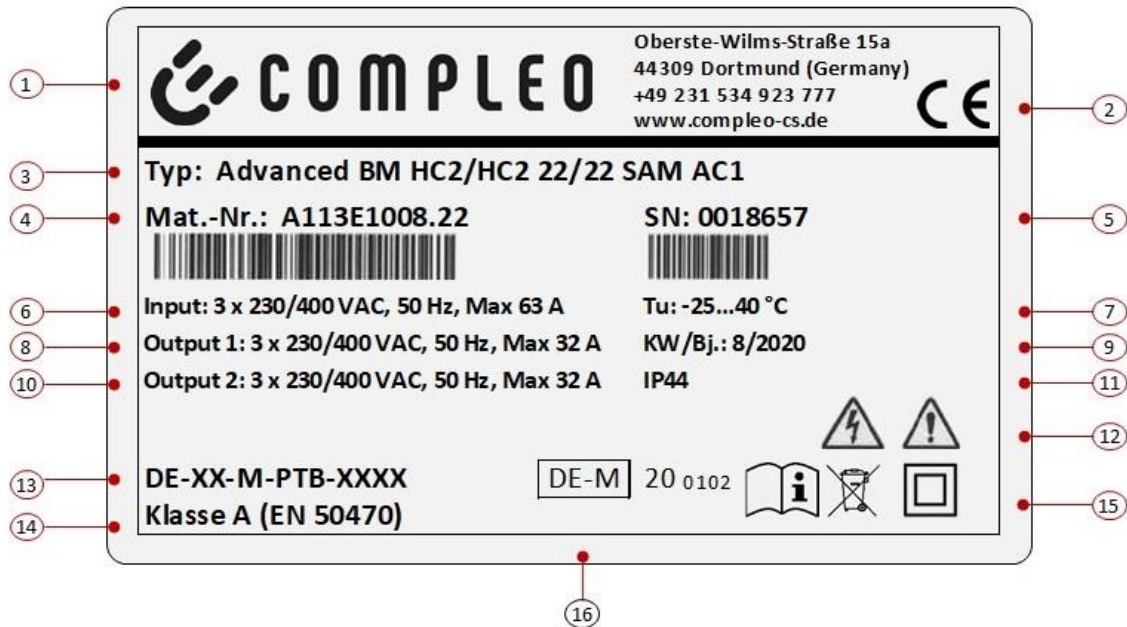



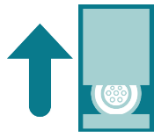









Illustration similar

The following information can be identified by means of the serial label:

- (1) Name of the manufacturer
- (2) Address/ Service number/ Website of the manufacturer
- (3) Type/ Installation type/ Charging interfaces/ Charging capacities of charging system
- (4) Material number or article number of the charging system
- (5) Serial number of the charging system
- (6) Input: Number of phases x voltage frequency input current
- (7) Ambient temperature
- (8) Output 1 AC: Voltage, max. current
- (9) Calendar week and year of manufacture
- (10) Output 2 AC: Voltage, max. current
- (11) Protection type and protection class of the charging system
- (12) Pictograms (safety instructions)
- (13) Number of the type examination certificate (for charging stations that comply with calibration law)
- (14) Accuracy class of the measuring instrument according to EN 50470 (for charging stations that comply with calibration law)
- (15) Pictograms (protection class, disposal, operating and maintenance instructions)
- (16) Metrology marking (for charging stations that comply with calibration law)

3.3 Scope of delivery

The scope of delivery of the Compleo DUO bm/ Compleo DUO fleet bm (Compleo ADVANCED bm) includes, in addition to the charging column, the following features and components:

		<p>Authentication:</p> <ul style="list-style-type: none"> RFID tag & RFID card (optional)
<p>(optional)</p>	<p>(optional)</p>	<p>Charging interfaces:</p> <ul style="list-style-type: none"> AO2 (socket with sliding cover type 2) alt. HC2 (spiral cable type 2)
		<p>(alternative)</p>
 <p>RGB</p>	<p>3-colour</p>	<p>Status displays and/or display:</p> <ul style="list-style-type: none"> Status LED
		<p>SAM or counter with viewing window:</p> <ul style="list-style-type: none"> Memory and display module alt. Counter with digital display
<p>(alternative)</p>	<p>(alternative)</p>	<p>Foundation:</p> <ul style="list-style-type: none"> Asphalt & concrete (BM) alt. Concrete base (BM)
		<p>Housing closure:</p> <ul style="list-style-type: none"> Pivoted lever
		<p>Documentation:</p> <ul style="list-style-type: none"> Circuit diagram Operating instructions including design drawings
 <p>(optional)</p>	 <p>(optional)</p>	<p>Installation accessories (optional):</p> <ul style="list-style-type: none"> Base filler Installation material

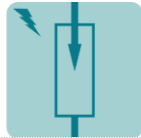

(optional)

Surge protection (optional):

- Surge arrester

3.4 Technical specifications

General information

Charging system	Compleo DUO bm/ Compleo DUO fleet bm (Compleo ADVANCED bm)
Charging mode	Mode 3/ IEC 61851
Charging interfaces	2 x type 2 socket with sliding cover or 2x type 2 plug with attached cable

Mains connection

Compleo DUO	Main switch + N/PE terminal
Max. connection cross-section	35 mm ²
Compleo DUO fleet	Busbar
Max. connection cross-section	95 mm ² with M8 cable lug

Data connection

Ethernet	Cable connection
Min. connection cross-section	26 AWG
Max. length	30 m

Electrical characteristics

Charging interface(s)	Type 2 socket with sliding cover	Type 2 socket with sliding cover Type 2 plug with attached cable
Max. rated current	32 A/ 3~	63 A/ 3~
Nominal voltage	400 V/ 3~	400 V/ 3~
Mains frequency	50 Hz	50 Hz
Network form	TT/ TN	TT/ TN
Protection class	II	II
Overvoltage category	III	III

Charging voltage	400 V/ 3~	400 V/ 3~
Max. charging capacity per loading point	11 kW	22 kW
Charging current	16 A/ 3~	32 A/ 3~

Protective devices

RCD	RCCB: 40 A/0.03 A, type A; RDC-DD: 6 mA	RCCB: 40 A/0.03 A, type B
MCB	2 x C20A, 1 x B10A	2 x C40A, 1 x B10A

Ambient conditions

Ambient temperature	-25 °C to +40 °C
Operating temperature (ø 24 h)	≤ 35 °C
Storage temperature	-25 °C to +50 °C
Relative humidity	≤ 95 % (non-condensing)
Altitude	≤ 2000 m above sea level

Mechanical data

Dimensions (H x W x D)	BM: 1441 x 400 x 225 (H x W x D)
Max. weight	BM: 38 – 46 kg (approximate depending on capacity and condition of the equipment)
Housing	Sheet Moulding Compound (SMC)/ glass fibre reinforced polyester
Housing closure	Pivoted lever mechanism for locking cylinder (single lock)
Protection type	IP44
Degree of contamination	3
Type/mounting	Base mounting

Product description

Communication interfaces

Data communication	TCP/IP
Data connection	LTE modem
(frequency/ transmission power)	(800 MHz, 900 MHz, 1800 MHz, 2100 MHz, 2600 MHz/ 23.0 ±1 dBm)
Backend communication	OCPP: 1.6J
RFID standard	Mifare Desfire, Mifare Classic;
(frequency/ transmission power)	(13.56 MHz/ 13.9 mW,11.4 dBm) (125 kHz; 134.2 kHz/ 26 mW, 14.1 dBm)

Legal regulations

2014/53/EU (Radio Equipment Directive)

2011/65/EU (RoHS Directive)

2001/95/EG (Directive on General Product Safety)

2012/19/EU (WEEE Directive)

(EU) 2019/1021 (EU-POP Ordinance)

(EU) 1907/2006 (REACH Regulation)

SVHC	EU no.	CAS no.
Lead (Pb)	231-100-4	7439-92-1
4,4'-isopropylidenediphenol (bisphenol A; BPA)	201-245-8	80-05-7

4 Transport, packaging and storage

4.1 Transport Inspection

Depending on the type and product scope of the charging system, it is delivered either upright or horizontally in appropriate transport and protective packaging. Depending on the type of charging system, air-cushioned protective films and/or cardboard boxes are used. The materials can also be used as underlay during subsequent assembly.

1. After unpacking, thoroughly inspect the charging system for transport damage.
2. Compare the serial number of the charging system with that of the delivery documents to exclude faulty deliveries.
3. Check delivery according to purchase and scope of delivery for completeness.
4. Proceed as follows in case of deviations or recognisable damages:
 - Do not accept delivery or only accept it conditionally.
 - Complaints must be reported immediately to the manufacturer in writing.

4.2 Storage conditions

The system should be stored in the same position that it was transported in. If this is not possible for undetermined reasons, it should be stored in the installation position of the charging system.

- Ambient temperature for storage: -25 °C to +50 °C
- Permissible relative humidity: maximum 95 % (non-condensing)
- For intermediate storage, store the charging system in the original packaging

5 Installation

Incorrect installation can lead to personal injury and damage to property. It must be ensured that the assembly and electrical installation are carried out professionally and that the local protective measures and the specifications of the energy supplier are observed.

The unit may only be installed by a qualified electrician and persons who are demonstrably qualified.

5.1 Location

For professional installation, safe operation and barrier-free access to the charging system, the following points must be observed when selecting the location.

- National or local regulations.
- Do **not** install the charging system in the hazard areas of:
 - Flammable, combustible and explosive materials
 - Running or jet water
- Do **not** install the charging system in the following areas:
 - Areas that are potentially explosive (e.g. gas filling stations)
 - Areas where backwater or storm water is to be expected
 - Areas where flooding is to be expected
 - Areas where heat domes or heat accumulation can occur
- The substrate must have sufficient strength and load-bearing capacity to withstand the mechanical loads.
- Provide sufficient space to maintain the minimum distances:
 - Approx. 1200 mm between two charging systems
 - 30 mm from the back of the charging system to other objects for mechanical installation on a base
- Ensure a sufficient fresh air supply for cooling the charging system and heat dissipation.
- Observe ambient conditions, see Technical Data.

5.2 Installation work

The assembly and installation work requires specific technical qualifications and expertise. There is a danger to life for persons who carry out work for which they have neither been qualified nor instructed. The work may only be carried out by persons who are familiar with it, have been informed about dangers and have the necessary qualifications.

Observe the national legal requirements and regulations during assembly and installation.

5.3 Mechanical installation

⚠ WARNING**Incorrect installation and start-up**

Improper performance of work can lead to serious injuries and damage to property.

- Work may only be carried out by trained specialist personnel.
 - Meet all safety requirements before installation.
 - Only carry out mechanical installation in a de-energized state.
-
- Provide sufficient free space for the installation. The installation site must be sufficiently accessible so that the charging system can be installed and serviced without interference.
 - The installation site must be chosen so that the cables of the cable management system do not protrude onto the road and do not come to rest between the kerb and the road.
 - Use a suitable lifting tool with sufficient load capacity during installation.

NOTE

The use of specific installation materials for the charging system may be necessary depending on the condition of the ground or special local conditions. The necessity must be considered individually at each location.

The following description of installation with specific installation material is exemplary. Local conditions are not dealt with in detail. Deviating procedures may only be initiated by competent persons.

5.3.1 Base mounted

Installation sequence

1. Select a suitable location.
2. Check parts and installation material for completeness.
3. Check the substrate.
4. Route the power supply cable.
5. Drill mounting holes.
6. Insert screw anchors.
7. Place and align the charging system.
8. Insert the power supply cable into the base.
9. Fasten the charging system with installation material.
10. Prepare electrical installation.

NOTE

A clearance of approx. 1200 mm should be provided between two charging systems or to the front or operating side of a charging system. If this is not the case, maintenance or service work or the use of the charging system may only be possible to a limited extent. No minimum distance must be maintained from the rear of a charging system to other objects when base mounted.

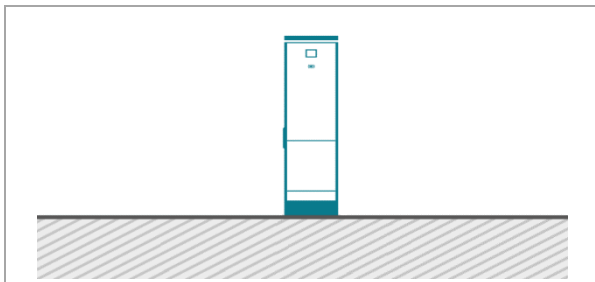

Fig. 2: Schematic diagram of installation

Installation takes place on prepared asphalt or concrete surfaces.

The charging system is then mounted and finally installed.

Refer to the design drawings in the Annex for the dimensions of the charging system.

The installation material for fixing is included in the scope of delivery.

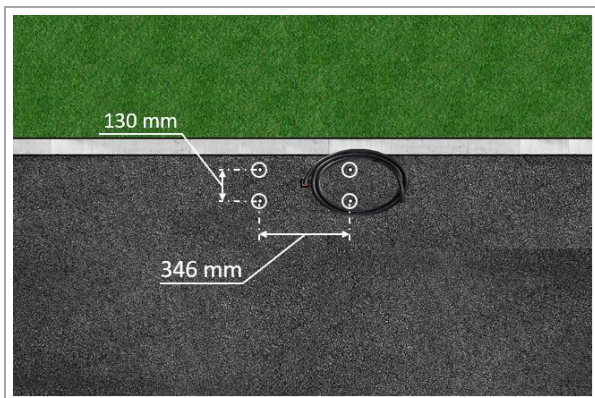

Fig. 3: Mounting holes

Installation requirements

- Substrate with sufficient layer thickness, consistency and bearing capacity
- Asphalt or concrete thickness of the substrate at least 120 mm
- Flat support surface
- Guidelines for boreholes:
 - \varnothing of the boreholes: 10 mm
 - Distances: 130 mm and 346 mm
 - Depth: 110 mm

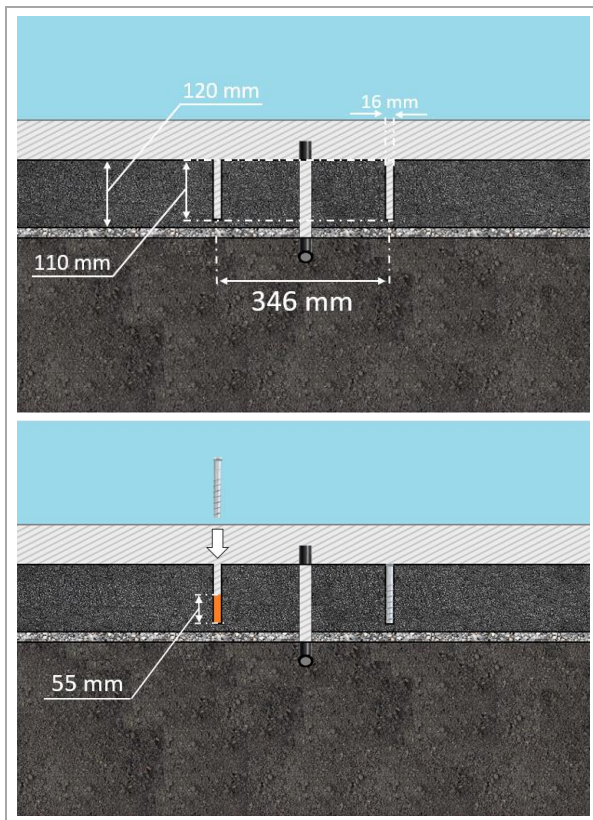

Fig. 4: Boreholes

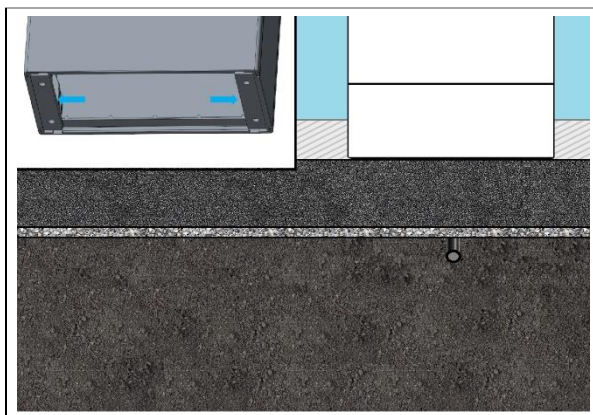

Fig. 5: Fastening the charging system

Carrying out installation

1. Mark boreholes.
2. Drill boreholes according to instructions.
3. Fill boreholes up to a height of 55 mm with injection mortar.
4. Insert screw anchor with internal thread (M 10) and an external diameter of 16 mm.
5. Allow the injection mortar to harden.

6. **⚠ WARNING** – Crushing of body parts due to unintentional lowering. Body parts must not be under lifted load.
Position and align the charging system over the boreholes so that the mounting holes of the charging system match the boreholes.
7. Insert the supply cable into the base from below.
8. Place one padding panel per side between the ground and the base foot bracket of the charging system.
9. Fasten the charging system with four screws (M 10 x 50).

NOTE

If the supply lines are not inserted into the base from below, it is recommended to close the lower boreholes with a base plate. The base plate is supplied as an option. For alternative cable routings, see the following page.

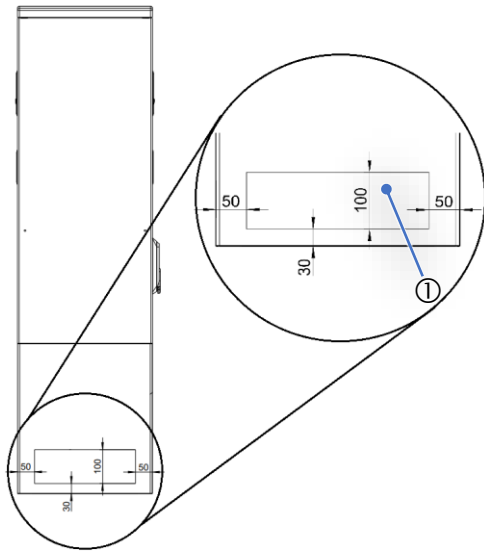
5.3.2 Lateral cable routing through the unit housing

1. Drill additional boreholes with a suitable drill in the defined area (1) on the side of the unit.
 - Keep a minimum distance of 60 mm between the outer diameters of the individual boreholes.
 - When drilling, make sure that the SMC is not delaminated.
2. Insert the gland and feed in the supply lines.
 - The insertion of the gland and the feeding of the supply cables must not reduce the IP degree of protection and IK degree of protection of the housing.
 - The gland must be selected on the basis of the place of use and the expected ambient conditions. Special attention should be paid to the temperature, humidity and UV resistance. Waterproof cable glands are recommended.
3. Install strain relief to protect the supply lines from being torn out.

5.3.3 Installation on SMC base

Installation sequence

1. Select a suitable location.
2. Check parts and installation material for completeness.
3. Dig the excavation pit.
4. Check the ground for consistency and load-bearing capacity.
5. Route the power supply cable.
6. Compact and level the ground.
7. Place and align the charging system.
8. Insert the power supply cable into the base.
9. Fill the excavation pit with excavated material and compact the excavated material.
10. Insert base filling material.
11. Place and align the charging system.
12. Fasten the charging system with installation material.
13. Prepare electrical installation.

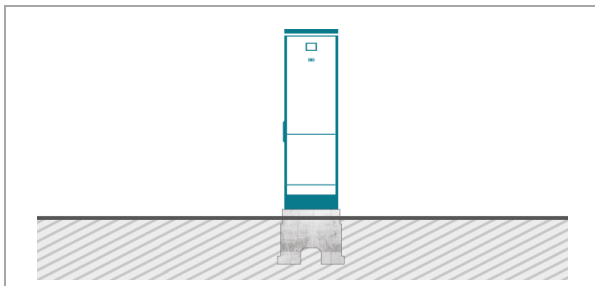

Fig. 6: Schematic diagram of installation

The SMC base is embedded in the ground.

The charging system is then mounted on the SMC base and finally installed.

Refer to the design drawings in the Annex for the dimensions of the charging system.

The installation material for fixing is included in the scope of delivery.

4x hexagon head screw M10x90 V4A, (1303108)

4x large diameter washer D10.5 V2A, (1302695)

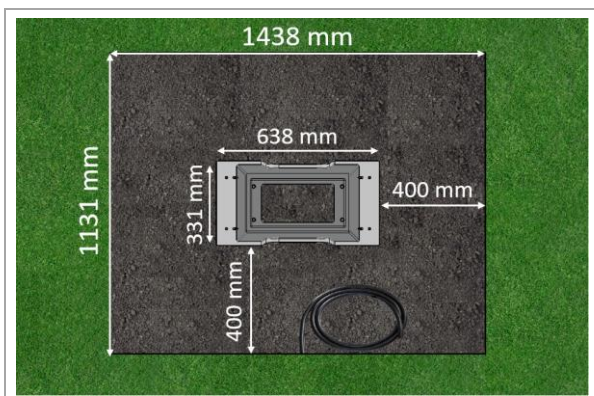
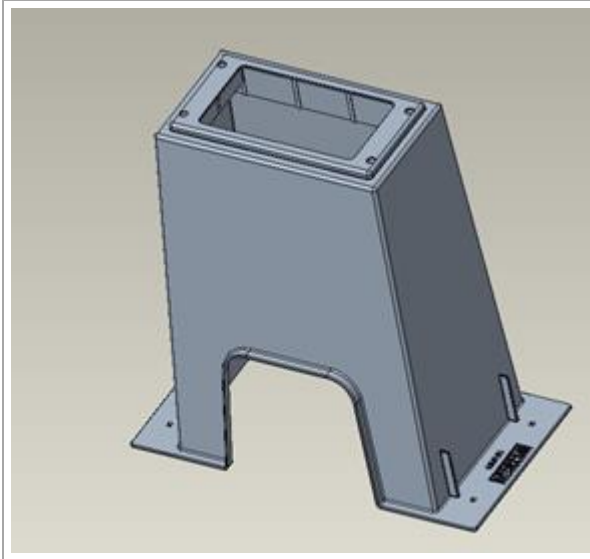

Fig. 7: Excavation pit (dimensions)

1. Dig an excavation pit and prepare it for the stable installation of the charging system.
 - Width: 1438 mm
 - Length: 1131 mm
 - Distance to all sides of the SMC base: 400 mm
 - Depth: 643 mm, so that the SMC base protrudes 20 mm from the ground
- Flat support surface of the substrate

Installation



The supply and data cables can be fed through the opening in the base at the front, back or top.

Additional boreholes for the cable feed can be drilled on the base side using a suitable drill.

Diameter of the boreholes:

60 mm (data cable)

110 mm (supply cable)

Height of the boreholes:

108 mm (supply cable)

233 mm (data cable)

or

408 mm (supply cable)

533 mm (supply cable)

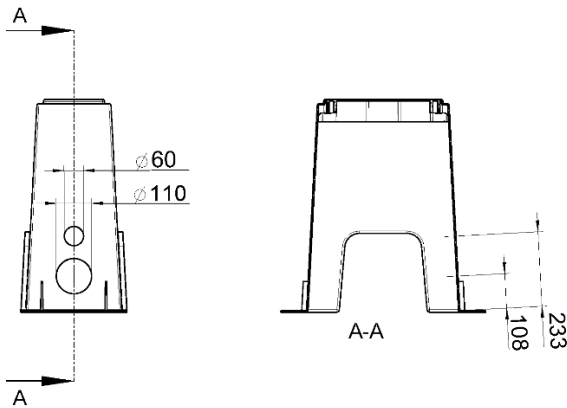

When drilling, make sure that the SMC is not delaminated.

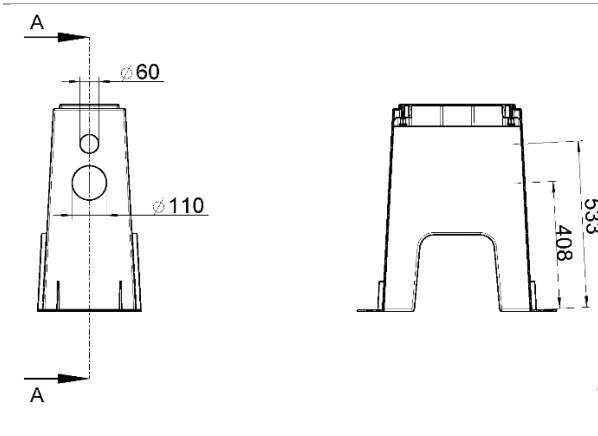

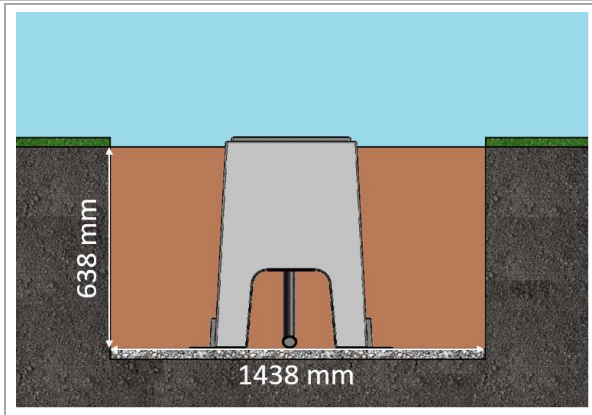

Fig. 8: Excavation pit

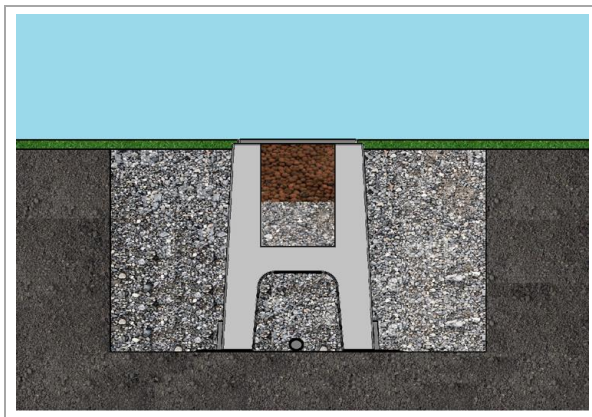

Fig. 9: Excavation pit filled with excavated material

Carrying out installation

2. Lower the SMC base into the excavation pit.
 - The upper edge of the ground level and the operating side of the charging system are marked on the base for orientation and alignment
 - Base protrudes 20 mm from the ground
3. Insert the power supply cable into or through the base.
4. Depending on the ground and the surrounding soil, it is necessary to embed the base in lean concrete on the right and left sides. Recommended on both sides; 4001 mm x 200 mm and a height of 150 mm.
5. Fill the excavation pit with excavated material again, compacting the soil every 200 mm.
 - Make sure that the filling of the pit reaches the surrounding ground level.
6. Fill the last 300 mm inside the base with base filling material.
 - ½ sack of filling material (Compleo)
 - The use of the filling material is recommended as it reduces the penetration of moisture into the charging system from the ground.
7. Compress the excavation material around the charging system.

Installation

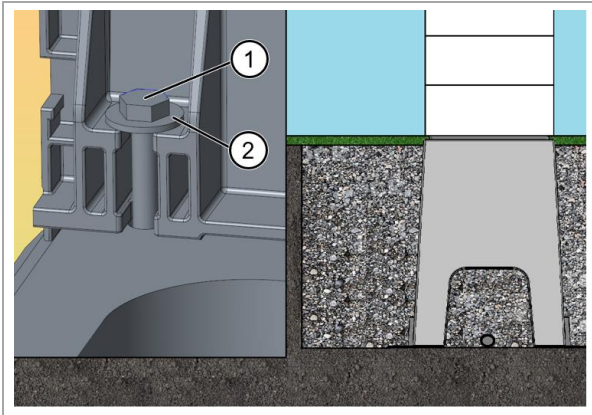

Fig. 10: Fastening the charging system

⚠ WARNING – Crushing of body parts due to unintentional lowering. Body parts must not be under lifted load.

Position and align the charging system over the boreholes so that the mounting holes of the charging system match the mounting holes in the base.

8. Hand-tighten the M10x90 screws (1) with washers (2) in the threads of the base fixing points. Ensure correct fit and then tighten crosswise.

- The installation material is included in the scope of delivery.

NOTE

To protect the charging system, we recommend to install an approach limiter (e.g. bollard).

5.3.4 Installation on concrete base

Installation sequence

1. Select a suitable location.
2. Check parts and installation material for completeness.
3. Dig the excavation pit.
4. Check the substrate.
5. Route the power supply cable.
6. Compact and level the ground.
7. Place and align the charging system.
8. Insert the power supply cable into the base.
9. Fill the excavation pit with excavated material and compact the excavated material.
10. Insert base filling material (mandatory).
11. Place and align the charging system.
12. Fasten the charging system with installation material.
13. Prepare electrical installation.

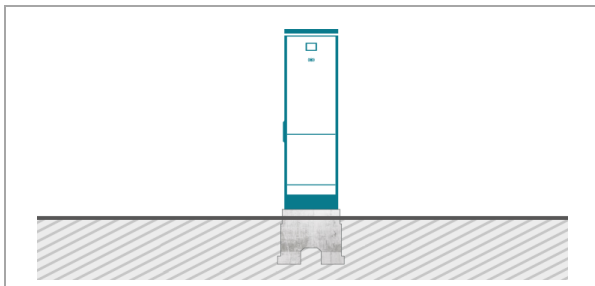

Fig. 11: Schematic diagram of installation

The concrete base is embedded in the ground.

The charging system is then mounted on the concrete base and finally installed.

Refer to the design drawings in the Annex for the dimensions of the charging system.

The installation material for fixing is included in the scope of delivery.

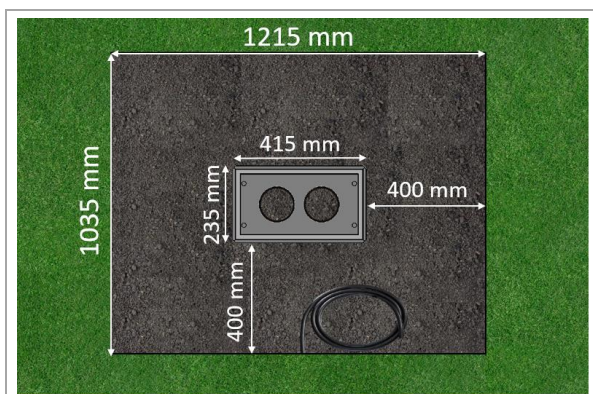

Fig. 12: Excavation pit (dimensions)

Installation requirements

- Excavation pit
 - Width: 1215 mm
 - Length: 1035 mm
 - Distance to all sides of the concrete base: 400 mm
 - Depth: 600 mm
- Flat support surface of the substrate

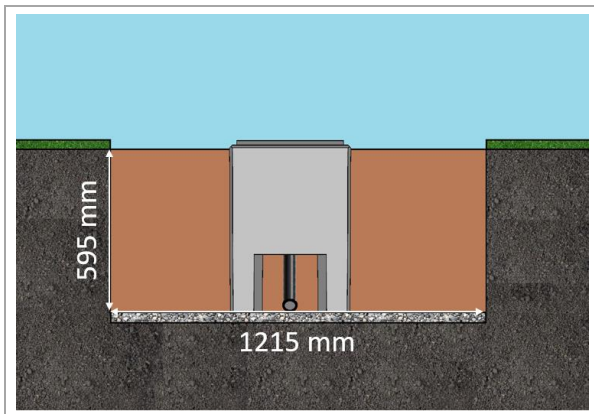

Fig. 13: Excavation pit

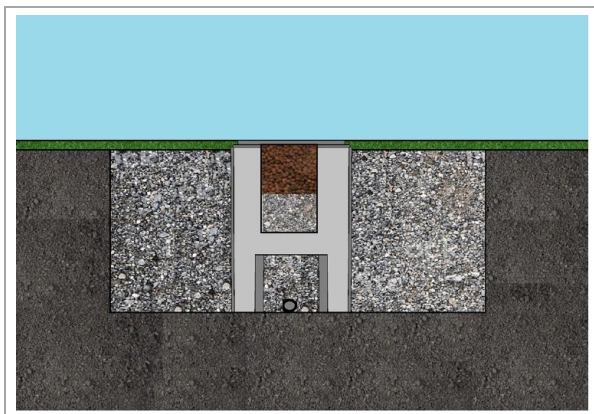

Fig. 14: Excavation pit filled with excavated material

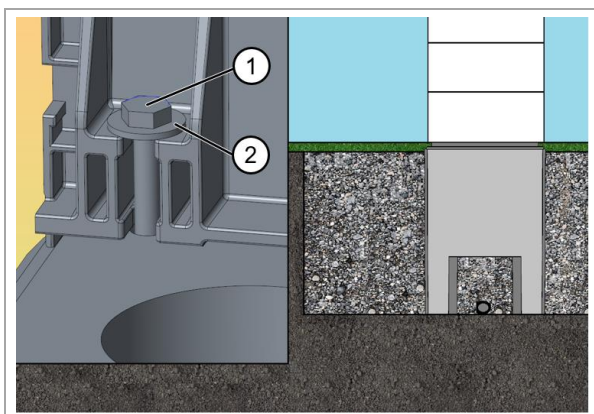

Fig. 15: Fastening the charging system

Carrying out installation

1. Dig an excavation pit and prepare it for the stable installation of the charging system.
2. Embed the concrete base into the excavation pit with suitable lifting gear.
 - The upper edge of the ground level and the operating side of the charging system are marked on the base for orientation and alignment
 - Base protrudes 20 mm from the ground
3. Insert the power supply cable into or through the base.
4. Fill the excavation pit with excavated material.
 - Make sure that the filling of the pit reaches the surrounding ground level.
5. Fill the last 300 mm inside the base with base filling material.
 - ½ sack of filling material (Compleo)
 - The use of the filling material is mandatory as it reduces the penetration of moisture into the charging system from the ground.
6. Compress the excavation material around the charging system.
7. **⚠ WARNING** – Crushing of body parts due to unintentional lowering. Body parts must not be under lifted load.
Position and align the charging system over the boreholes so that the mounting holes of the charging system match the mounting holes in the base.
8. Insert the power supply cable into the base.
9. Screw down the charging system with four M10x60 hexagon bolts (1) and a large diameter washer (2) placed underneath.
 - The installation material is included in the scope of delivery.

NOTE

To protect the charging system, we recommend to install an approach limiter (e.g. bollard).

5.3.5 Closure of the housing, single and double lock

Illustration similar

Opening the housing

1. Unlock the locks with the corresponding key.
2. Swing out pivoted lever and turn to the left.
3. Open the door.

If necessary, the profile half-cylinder lock can be replaced. For this purpose the fixing screw must be unscrewed.

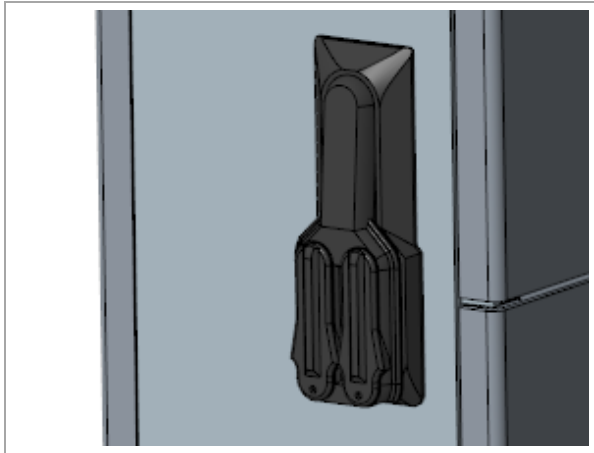
After replacing the lock, it must be secured again with the fixing screw.

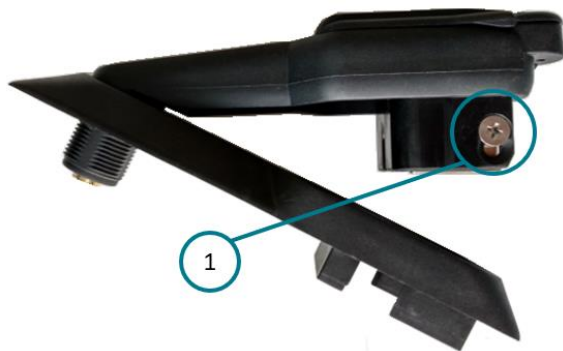

Illustration similar

NOTE

If no locking cylinder is installed inside the pivoted lever, the lever can only be opened using a suitable tool. A construction key is required to reopen a closed lock.

5.4 Electrical installation

⚠ DANGER**Danger due to electric current**

Touching live parts will result in electric shock with serious injury or death.

- Work on electrical components may only be carried out by a qualified electrician and in accordance with electrical engineering rules.
 - Ensure they are de-energised and take suitable protective measures.
-

- For safe disconnection during installation work, disconnect the charging system from the power supply.
 - Switch off the circuit breaker or main switch.

Observe the national legal requirements and regulations during electrical installation. In Germany, these include the following safety requirements:

- DIN VDE 0100-100
- DGUV Regulation 1
- DGUV Regulation 3+4
- TRBS 1201

⚠ DANGER**Danger due to electric current**

Touching live parts will result in electric shock with serious injury or death.

- Only carry out work on electrical components after a period of more than 5 minutes.
-

5.4.1 Power supply cable

NOTE

Aluminium conductors must not be used. Use copper conductors only.

Compleo DUO: Main switch + N/PE terminal

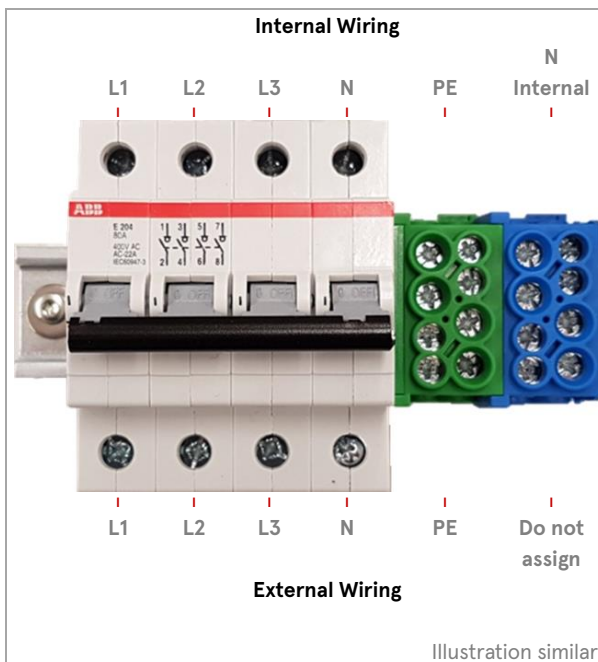

Fig. 16: Main switch

Illustration similar

1. Cut the supply cable to length as required.
2. Strip the insulation from the individual 12 mm wires and attach the wire sleeves.
3. Connect all conductors of the power supply cable to the external wiring side as shown in the adjacent figure.

With the existing main switch (tightening torque = 2.5 Nm) + N/PE terminal (tightening torque M6 = 2.5 Nm, tightening torque M8 = 3.5 Nm), the cross-section of the conductors of the supply cable to be connected can be between 2.5 and 35 mm².

The conductor cross-section must be selected taking into account the maximum charging capacity and the length and installation method of the power supply cable.

4. Make sure that the individual wires are connected correctly and that the clamping screws are tightened according to the specified tightening torque.
5. Install surge and lightning protection according to the installation conditions and the resulting planning.
6. Replace all covers that may have been removed previously.

Compleo DUO fleet: Busbar system

Fig. 17: Busbar

1. Cut the supply cable to length as required.
2. Strip the insulation from the individual wires and apply heat shrink tubing.
3. Attach the cable ring lugs.
4. Ensure that the heat shrinking tubing is seated correctly to avoid short circuits. The heat shrinking tubing must not reach the contact surface of the cable lug.
4. Connect all conductors of the power supply cable to the external wiring side as shown in the adjacent figure. Fasten the cable ring lugs with screws of type M8 (tightening torque = 20 Nm) (thread length 20 mm).
5. The conductor cross-section must be selected taking into account the maximum charging capacity and the length and installation method of the power supply cable.
6. Make sure that the individual wires are connected correctly and that the clamping screws are tightened according to the specified tightening torque.
7. Install surge and lightning protection according to the installation conditions and the resulting planning.
8. Replace all covers that may have been removed previously.

NOTE

When electrically installing a charging system, the applicable surge protection standards must be observed. Compleo Charging Solutions AG recommends the use of a type 1+2 surge arrester for charging stations with public mains connection in the pre-meter area. Charging stations which are supplied from distribution boards that are already protected must be equipped with at least one type 2 surge arrester. In addition, additional surge protection should be provided for both AC and DC lines in DC charging systems with cable runs of more than 10 metres between the control unit and the power unit.

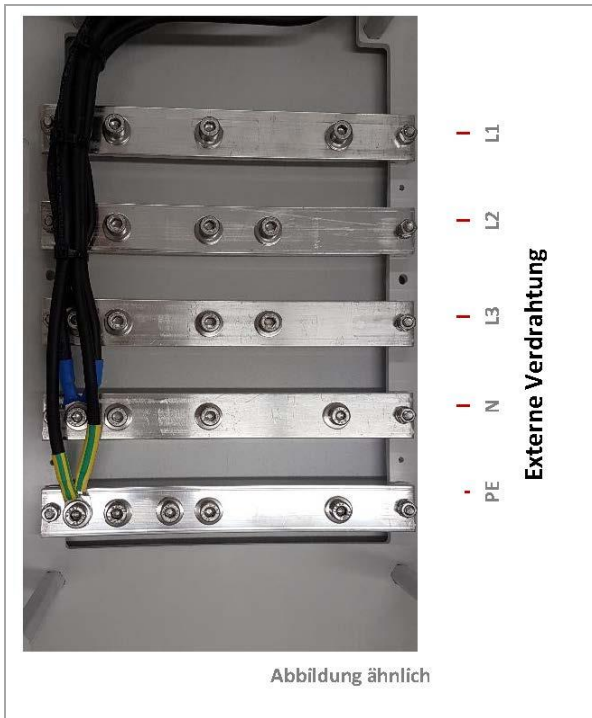
NOTE

Any change to an adjustable current value of the charging point or charging points may only be made by a qualified electrician.

Installation

Phase sequence when setting up several charging systems

NOTE

In order to ensure optimum utilisation of the connected load as well as to avoid high unbalanced loads with many simultaneous single-phase charging processes, it is absolutely necessary to connect the charging systems out of phase.

In the example shown below, the phase sequence coming from the mains was shifted by one phase compared to the internal phase sequence of the charging systems.

From	grid connection to	charging station 1 to	charging station 2 to	charging station 3
Phase	L1 →	L1 →	L3 →	L2
Phase	L2 →	L2 →	L1 →	L3
Phase	L3 →	L3 →	L2 →	L1

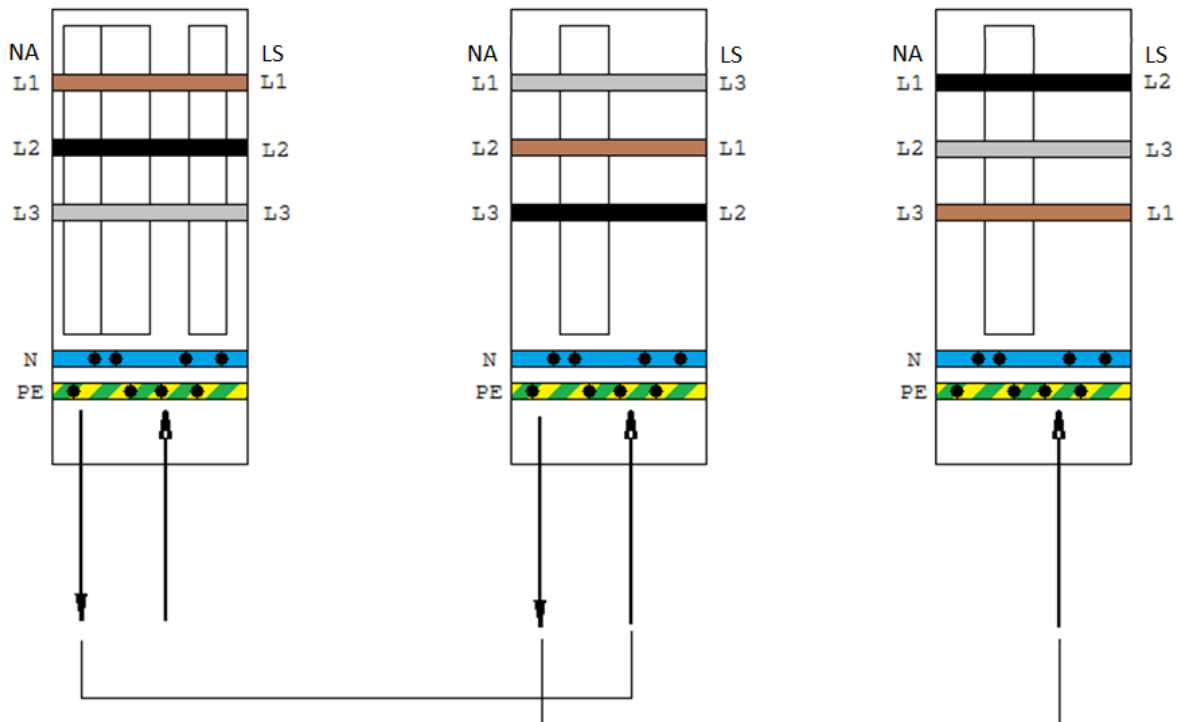

NC = network connection
LS = charging system

NOTE

If more than 3 charging stations are connected, the scheme should be applied continuously.

NOTE

If load management is ordered, it is imperative that the charging system numbering specified by the factory is observed. For easier traceability, a corresponding sticker with the mains connection configuration to be observed is attached inside the charging system.

5.4.2 Equipotential bonding
NOTE

When connecting a type 1+2 surge arrester, it must be ensured that the equipotential bonding connection is connected to a possibly installed equipotential bonding rail or to a local earth electrode. When connecting a type 2 surge arrester, the equipotential bonding connection does not necessarily have to be connected. The manufacturer's instructions must be read and observed. The back-up fuse of the charging system must not exceed 125 A.



The necessary equipotential bonding is carried out via the permanently mounted terminal in the housing.

- Terminal on 2 levels, each equipped with 2 clamping points for connecting a cable cross-section of 16 mm², or 25 mm².
- The connection can also be made on site with a copper earthing rod of the appropriate diameter.
- All conductors are to be mounted according to the illustration and with suitable tools (M = 2.5 – 3.5 Nm).

NOTE

All connected cables must be made of copper. Other materials do not correspond to the intended use and impair the functional safety.



All clamping points are designed to accept only round cross-section profiles.

Wire end ferrules with a square profile must be brought to a corresponding profile using a suitable crimping tool.

Installation

NOTE

For electrical installation, the applicable standards for surge protection must be observed. We recommend the use of a type 1+2 surge arrester for charging stations with public mains connection in the pre-counter area. Charging stations which are supplied from distribution boards that are already protected must be equipped with at least one type 2 surge arrester. In addition, for DC charging systems with cable runs of more than 10 metres between the operating and power units, additional surge protection should be provided for both the AC and DC lines.

NOTE

The necessary torques of the main switch or the protective conductor and neutral conductor terminals must be observed. The torques can be taken from the corresponding data sheets.

NOTE

If type 1 surge protection is installed, an additional connection to the equipotential bonding or the local earthing system is required. A separate equipotential bonding rail is provided in the charging station for this purpose.

NOTE

Any change to an adjustable current value of the charging point or charging points may only be made by a qualified electrician.

5.5 Data connection cable

If it is necessary to connect an individual charging station to a network by means of a cable, this must be done using a pre-installed cable connector. The cable connector is prepared on the system side and must be connected on the mains side during electrical installation. Open the cable connector on the mains side and prepare the cable according to the following figures.

ATTENTION

The minimum cross-section of the individual strands of the network cable must be below AWG 26. When using a smaller cross-section than AWG 26, it cannot be guaranteed that a connection can be established.

NOTE

As a network cable to be used on the network side, we recommend using a cable with the following designation and article number:

- Designation: HELUKAT 600E S/FTP PVC
- Article number: 802167, S/FTP 4x2xAWG23/1 PVC (S-STP)

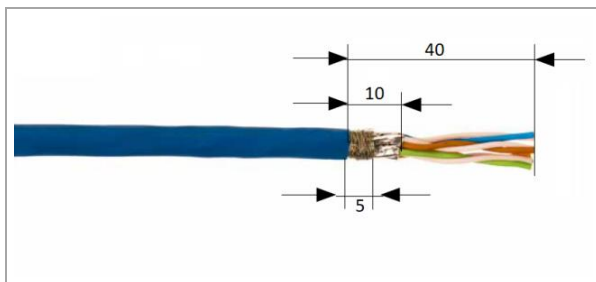

Fig. 18: Stripping the cable

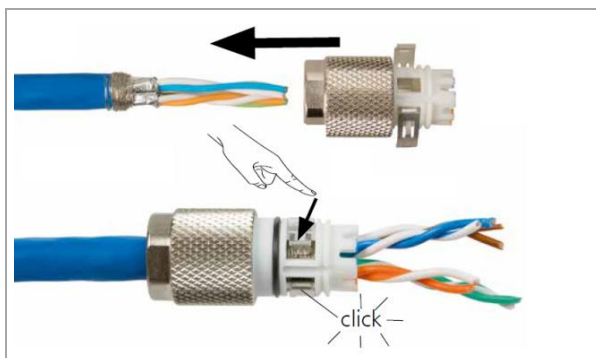

Fig. 19: Sliding on the connecting piece

1. Strip 40 mm of insulation from the cable as shown in the adjacent figure.
2. Wrap the braided shield evenly around the foil shield at the end of the jacket over a width of 5 mm.
3. Remove the foil shield so that it only protrudes 10 mm from the jacket.
4. Push the connecting piece onto the prepared cable.
5. Secure the connecting piece by locking the two shield clamps.
 - Make sure that the cables are correctly assigned to the corresponding gap (colour on colour).
 - If crossing of wire pairs is necessary, this procedure must be carried out before the connecting piece is inserted.

White plastic cap

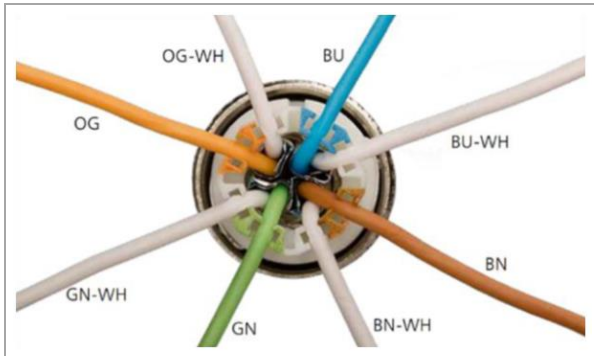

Fig. 20: Screwing on the connecting piece

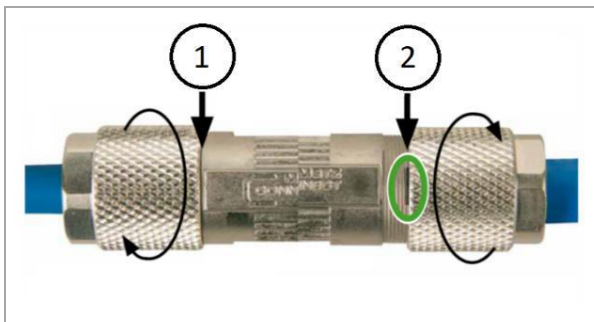

Fig. 21: Closing the screw connection

6. Connect the individual wires of the cable as shown in the adjacent figure.
7. Cut the wires with an electric cutter flush with the housing.
8. Screw the connecting piece to the cable connector.
 - How far the connecting piece has to be screwed onto the cable connector depends on the diameter of the network cable used on the network side.
 - For diameters up to 9 mm, the cable connector must be completely closed (1).
 - For diameters between 9.1 mm and 9.7 mm, close the screw connection up to the vertical marking of the cable connector (2).

5.5.1 RJ45 connector

If a connection to a network by means of an internally installed switch is required (depending on the equipment), this is to be realised using an RJ45 connector. The connector is enclosed and must be connected during electrical installation. The connector must be prepared according to the following illustrations.

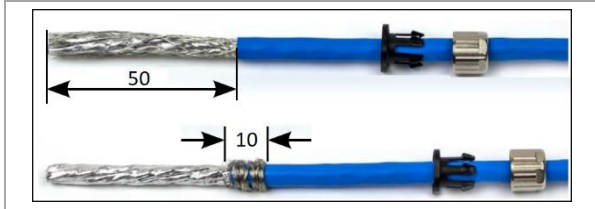

Fig. 22: Stripping the cable

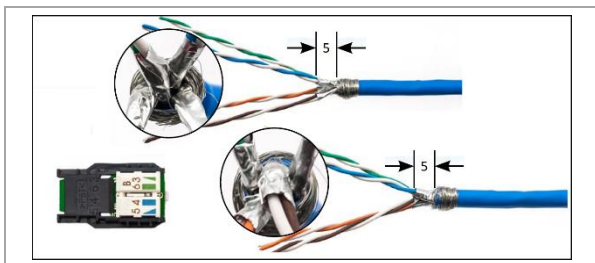
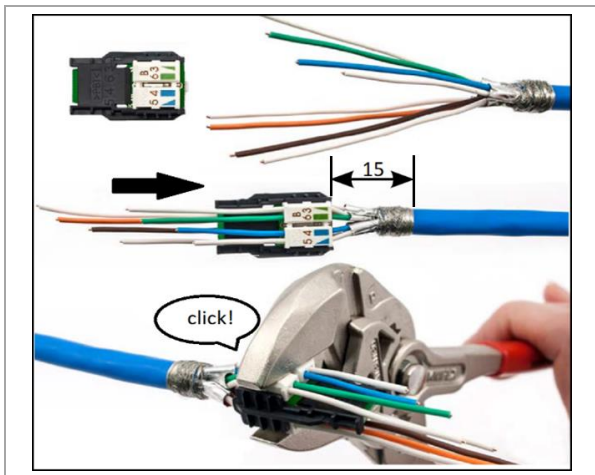
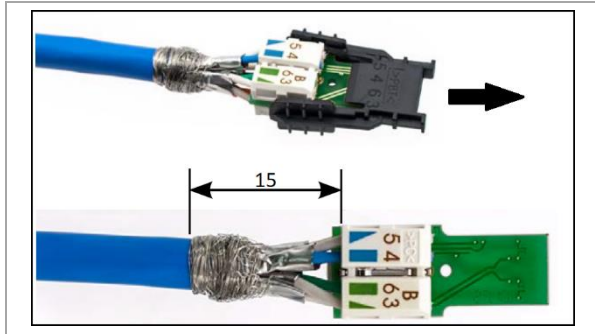

Fig. 23: Sliding on the connecting piece



1. Strip 50 mm of insulation from the cable as shown in the adjacent figure.
2. Push the cable gland over the stripped part onto the cable.
3. Wrap the braided shield evenly around the foil shield at the end of the jacket over a width of 10 mm.
4. Remove the foil shield so that it only protrudes 5 mm from the jacket.
5. Pre-sort wire pairs so that the colours of the manager and the wires match. This can result in the two versions shown, depending on which end of the network cable is present.
6. Untwist the wires and insert them into the wire manager according to the colour assignment.
7. Secure all wires in the wire manager with a pliers wrench. A click must be heard to indicate successful fastening.

Installation



- The distance between the beginning of the wound braided shield and the wire manager must not exceed 15 mm.

8. Cut off the wires protruding from the wire manager with an electric cutter so that the ends are flush. The protrusion must not exceed 0.5 mm.
9. Remove the black cap from the cable manager.

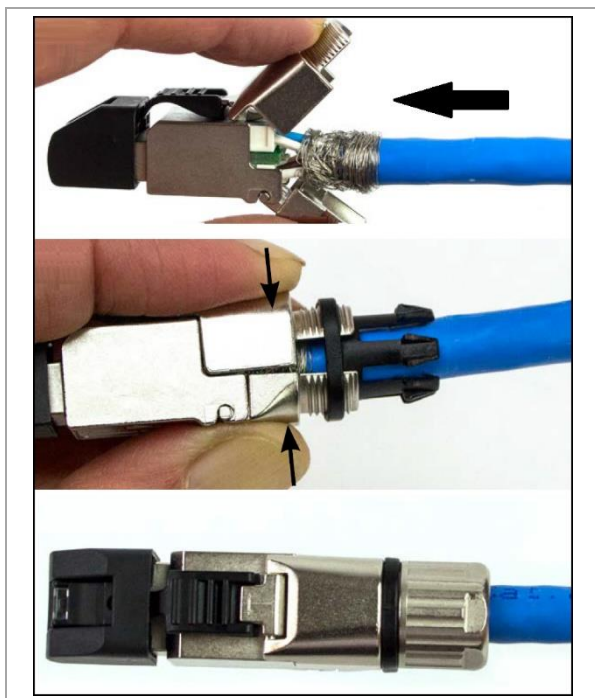

10. Push the wire manager into the RJ45 connector housing.
11. Close the fastener around the wound braided shield. Make sure that no strands of the braided shield protrude from the connector.
12. Push the strain relief onto the fastening of the connector.
12. Attach the gland to the connector. The torque to be applied is approx. 1 Nm and can be achieved with an open-end spanner size SW13.

6 Commissioning

Commissioning must be carried out by a qualified electrician or by a person trained and instructed in electrical matters. The effectiveness of the protective measures and the correct mechanical and electrical installation must be checked by a qualified electrician.

Commissioning may only be carried out when all necessary internal covers are fitted and the housing is completely closed.

Observe the national legal requirements and regulations during commissioning.

The correct mechanical installation is checked according to the following criteria:

- ☑ The degree of protection of the housing is not reduced or removed
- ☑ The charging system has a good optical condition
- ☑ The specifications for the buried depth of the housing or the specifications for the mounting height were complied with
- ☑ The housing has a safe installation condition according to its installation version

The correct electrical installation is checked according to the following criteria:

- ☑ All electrical components are functional and not damaged
- ☑ All display elements of the charging system are functional, visible and can be read
- ☑ The function of any installed residual current circuit breakers can be verified by pressing a button
- ☑ The function of any installed counters is available and readable
- ☑ The function of the charging system can be verified by means of a charging process
- ☑ The electrical installation was carried out in compliance with all safety and warning instructions and the listed safety requirements

DANGER

Danger due to electric current

Damage to the charging systems or components may expose live parts.

Touching live parts will result in electric shock with serious injury or death.

- Only operate the charging system when it is undamaged.
- In the event of damage, immediately disconnect the charging system from the power supply at the circuit breaker and take suitable safety measures to prevent it from being switched on again.
- Work on electrical components may only be carried out by a qualified electrician.
- Repair work may only be carried out by the customer service.

6.1 Testing the charging system



Fig. 24: Function simulator

The functionality of the installed charging system can be tested either with a vehicle or with a function simulator.

With the function simulator it is possible to simulate the functions of an electric vehicle and check the functionality of a charging system or charging point.

The figure shows an example of a function simulator for testing an AC charging system or AC charging point.

Another suitable test device must be used for all metrological tests.

6.2 System start-up

After the charging system has been correctly installed, the system can be started.

1. Switch on the main switch of the charging system.
2. Switch on the line and residual current circuit breaker.

The system starts up.

The duration of the system start-up may vary depending on the type of charging system, configuration and product characteristics. The successful completion of the system start-up is indicated by the status LEDs and the display according to the configuration and product scope of the charging system. The average start-up time is approx. 60 seconds.

A successful system start-up is indicated by the LED of the respective charging point temporarily lighting up green. In the case of a charging system with display, the message "Ready for operation" also appears for the respective charging point.

In addition to the displays mentioned above, the current counter reading and the message "Ready for operation" are shown on the display of any memory and display module (SAM) installed.

NOTE

After start-up, the charging system can be connected to the DUCTO configuration software in order to make settings.

If explicitly requested by the customer, the backend connections can be configured and tested at the factory. In this case, the backend connects directly to the associated charging system after applying the operating voltage. This process may take a few minutes.

6.3 Configuration of the charging system with Compleo DUCTO

Compleo DUCTO refers to the software used to manage Compleo charging systems using an end device.

Various parameters of the charging system can be set via the configuration interface.

The charging system management information is stored on the charging system itself. By specifying the IP of the charging system in the browser of a suitable end device, such as a notebook, a start page is called up and the connection to the charging system is established. After logging in, an overview of the parameters that can be called up or changed is listed.

To connect to the charging system, the end device used must have an IP address in the same IP address range.

NOTE

The following steps are illustrated using the example of a network configuration with Microsoft Windows 10 and a simulated charging system.

The user must have administrator rights for network configuration.

6.3.1 Creating a network connection



1. Connect a network-compatible end device or computer to the data line of the charging system.
2. Follow the command path: Control Panel -> Network and Internet -> Network Settings.
3. Show and open the properties of the corresponding Ethernet connection by right-clicking.

Commissioning

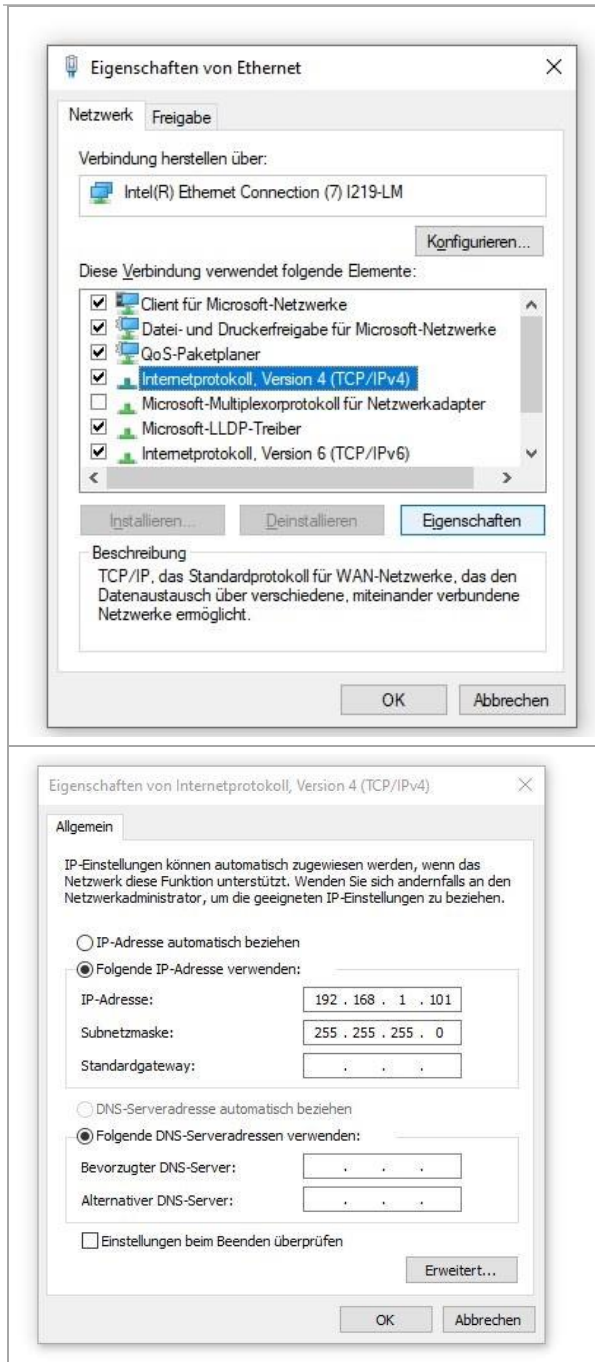

4. Open Properties of <...(TCP/IPv4)>.

5. Enter the IP address from the range 192.168.1.xxx.

Note: The IP 192.168.1.100 is assigned for the charging station and must not be used for the configuration of the end device or the computer.

The charging system is displayed as a network connection.

6.3.2 Calling up the configuration interface



1. Identify password on DUCTO sticker.
 2. Open the local browser and enter the following IP address:
https<colon>//192.168.1.100.
- The DUCTO start page is displayed.

6.3.3 Operator login

The start page shows information about the charging status of the charging interfaces.

After logging in as an operator, the user can set various parameters such as acoustic and visual signals.

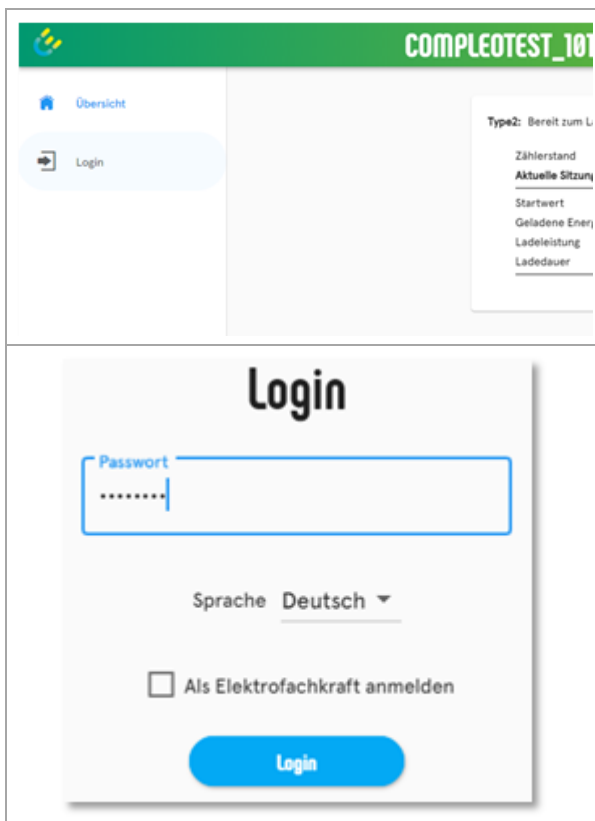

1. Click <Login>.
- The Login window is displayed.
2. Select language.
 3. Enter password.
 4. Click <Login>.
- The configuration interface is displayed.

6.3.4 Changing parameters

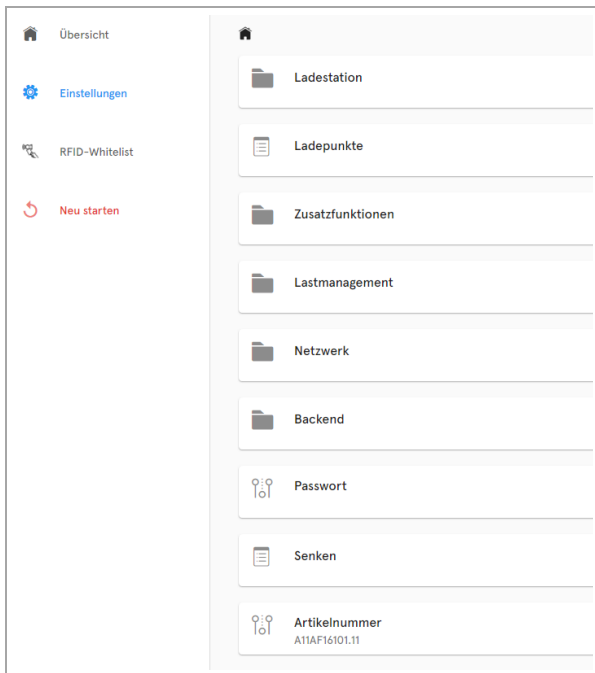

1. Click the desired button.
- The settings for changeable parameters or other buttons are displayed.

Optional: Changing the password

2. Click the <Password> button and follow the instructions.

ATTENTION

The password cannot be reset to the initial password after the password has been changed. The current password must therefore be kept carefully.

Example: Changing the acoustic signals

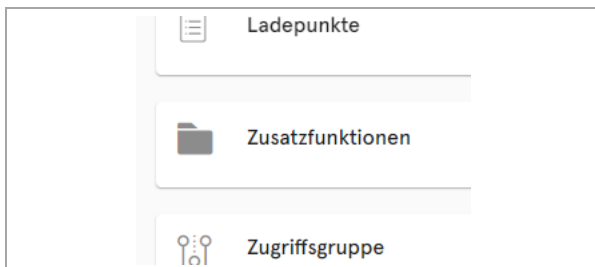

1. Click the <Additional functions> button.



- The buttons for these functions are displayed.
2. Click the <Deactivate acoustic signals> button.

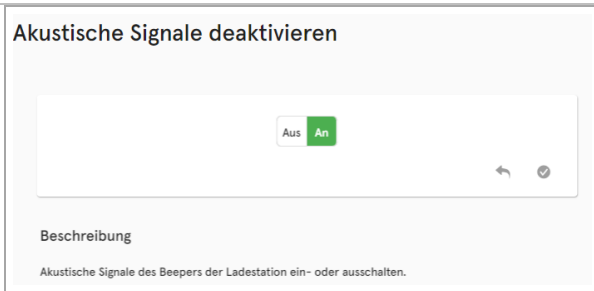

- The settings for the acoustic signals are displayed.
- 3. Click the <Off> button.



- The button is highlighted in red.
- 4. Confirm selection by clicking on the green button.

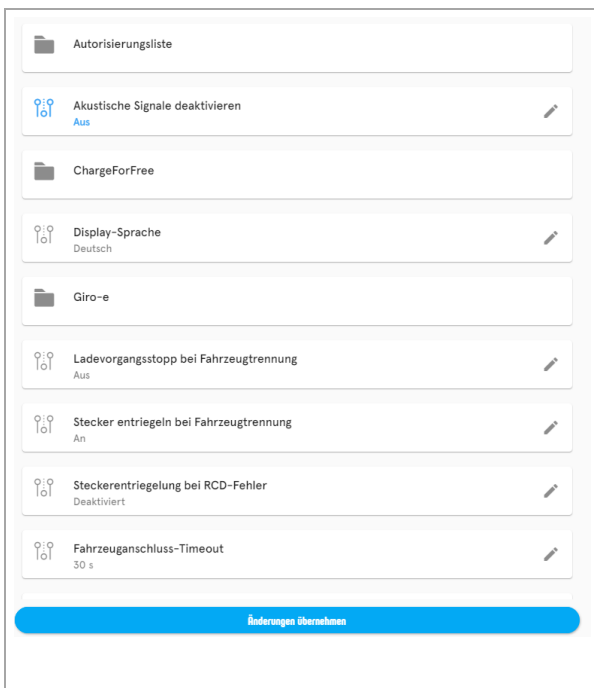

- The blue <Apply changes> button is displayed in the left column of the configuration.
- 5. Click the <Apply changes> button.

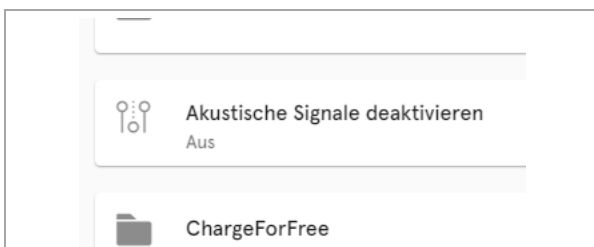

- The selected status is displayed on the button.

Commissioning

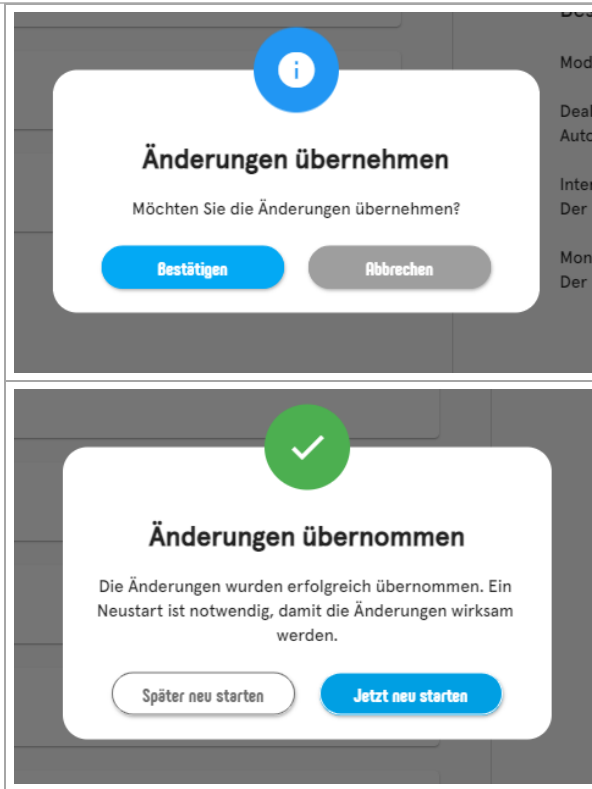

- The <Apply changes> button is displayed in the left column of the configuration.
- 6. Click the <Apply changes> button and follow the instructions.
- 7. Perform a restart.
- The changes are adopted.

6.3.5 Log in as electrician

If the "Log in as electrician" checkbox is ticked when entering the password, the instructed electrician can make advanced settings for configuring the charging system:

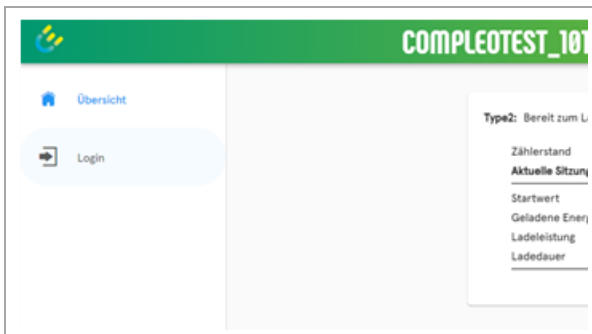

1. Click <Login>.

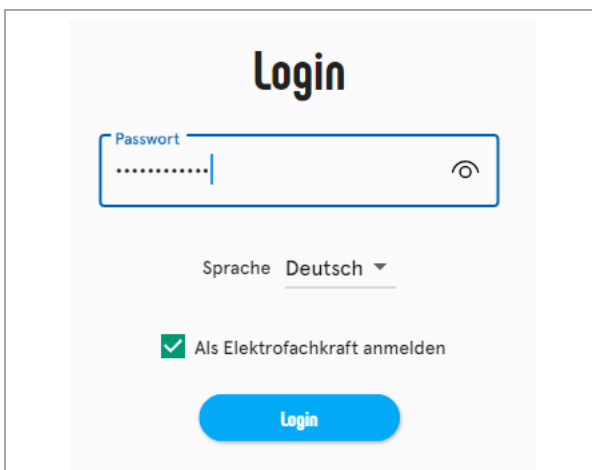

- The Login window is displayed.
- 2. Select language.
- 3. Select the <Log in as electrician> checkbox by clicking on it.
- 4. Enter password.
- 5. Click <Login>.

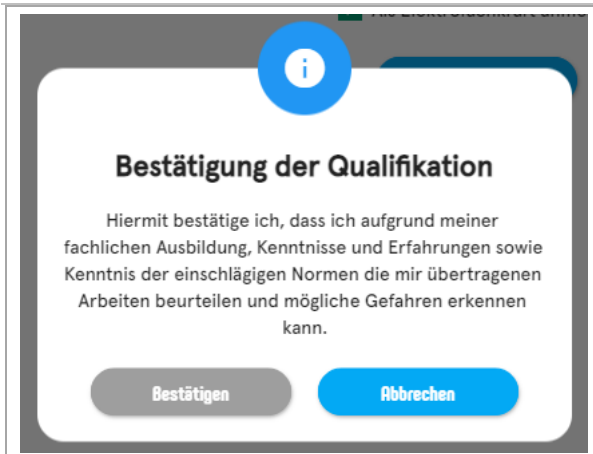

6. Confirm qualification.
 - The configuration interface is displayed.

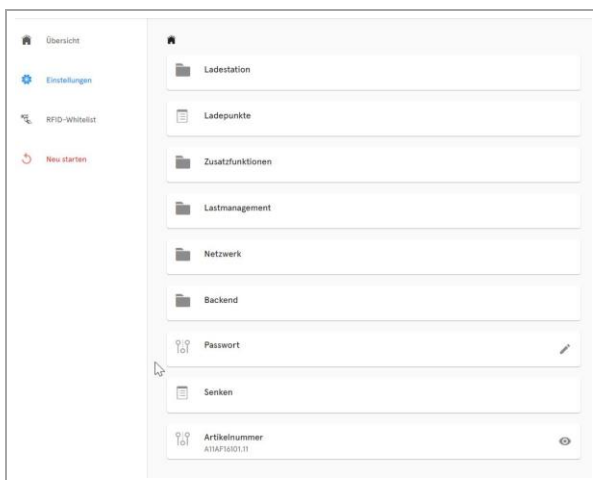

7. Click the topic and follow the instructions. See also "Example: Changing the RCD test cycle"

Optional: Changing the password

8. Click the <Password> button and follow the instructions.

ATTENTION

The password cannot be reset to the initial password after the password has been changed. The current password must therefore be kept carefully.

Example: Changing the RCD test cycle

Commissioning

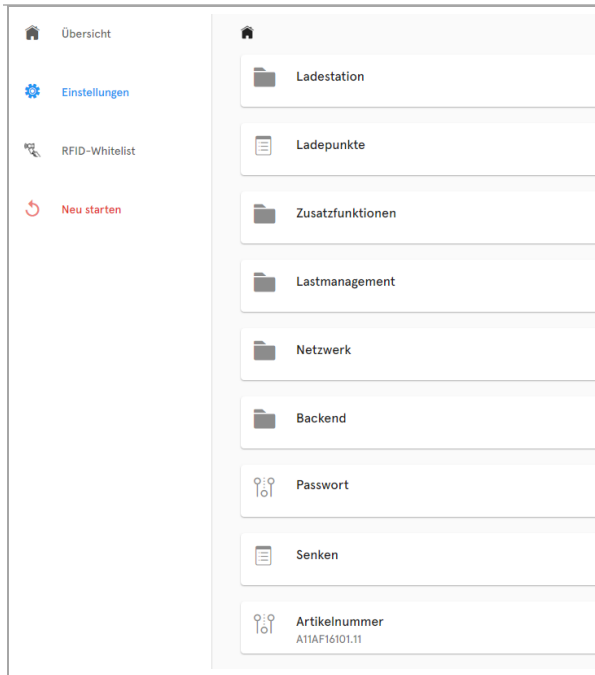

1. Click the <Charging station> button.

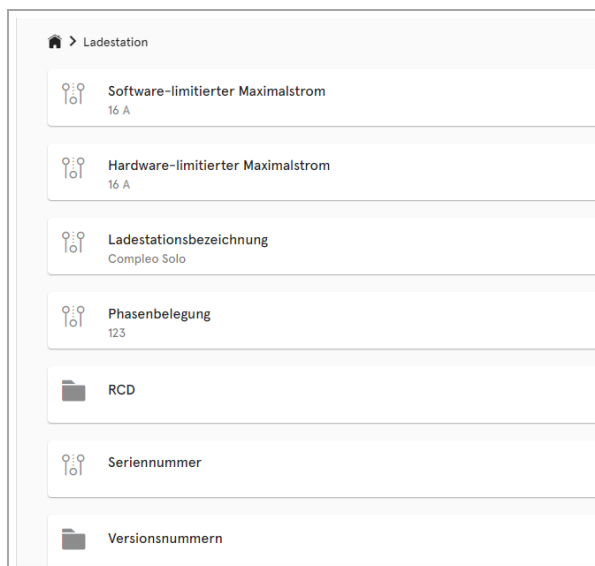

- The settings for the parameters of the charging station are displayed.
2. Click the <RCD> button.

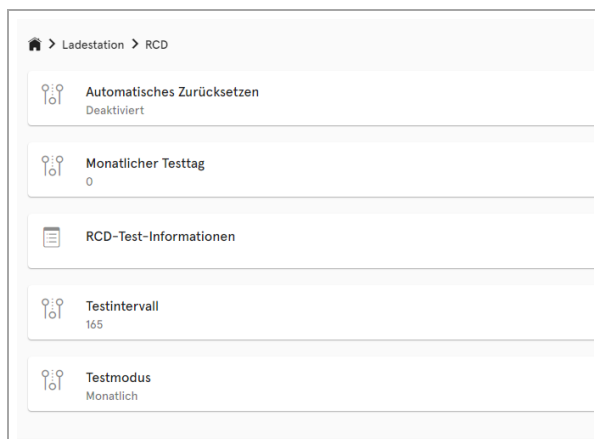

- The settings for the RCD residual current device are displayed.
3. Click the <Test mode> button.

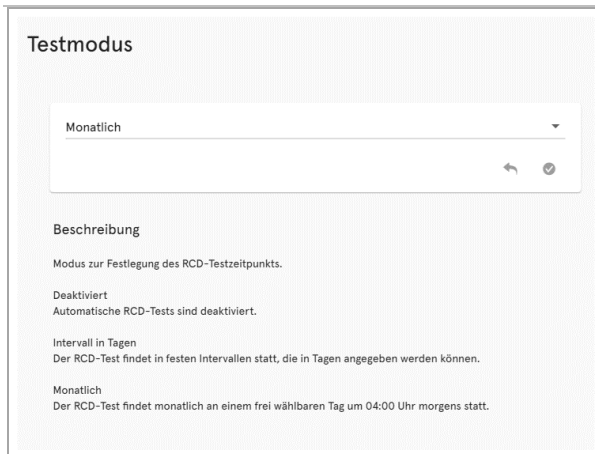

☑ The settings for the test mode are displayed in the right column of the configuration.

4. Click to open the selection field.

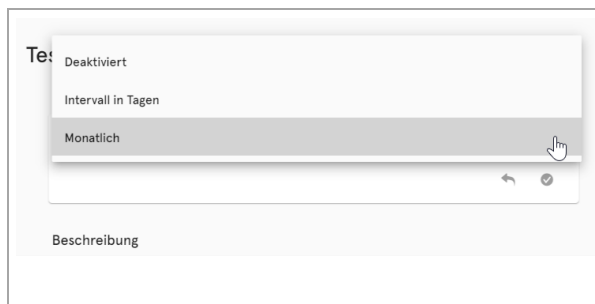

☑ The selection options are displayed.

5. Select a new cycle for the test mode.

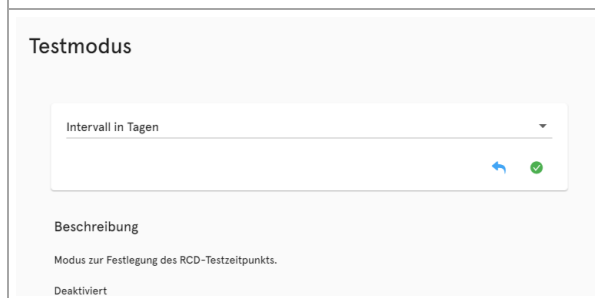

☑ The selected cycle is displayed.

6. Confirm selection by clicking on the green button.

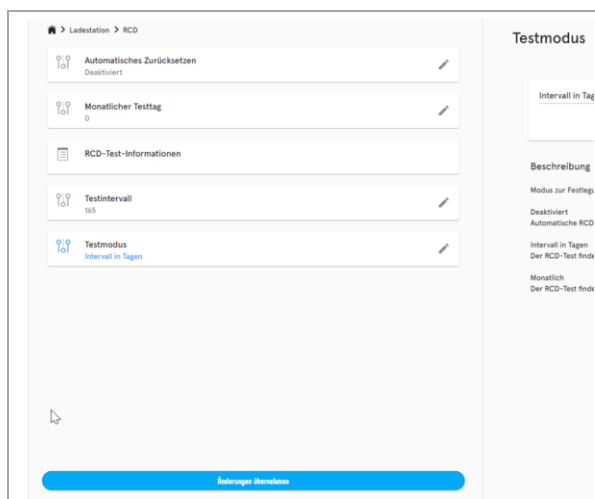

☑ The blue <Apply changes> button is displayed in the left column of the configuration.

7. Click the <Apply changes> button and follow the instructions.

Commissioning

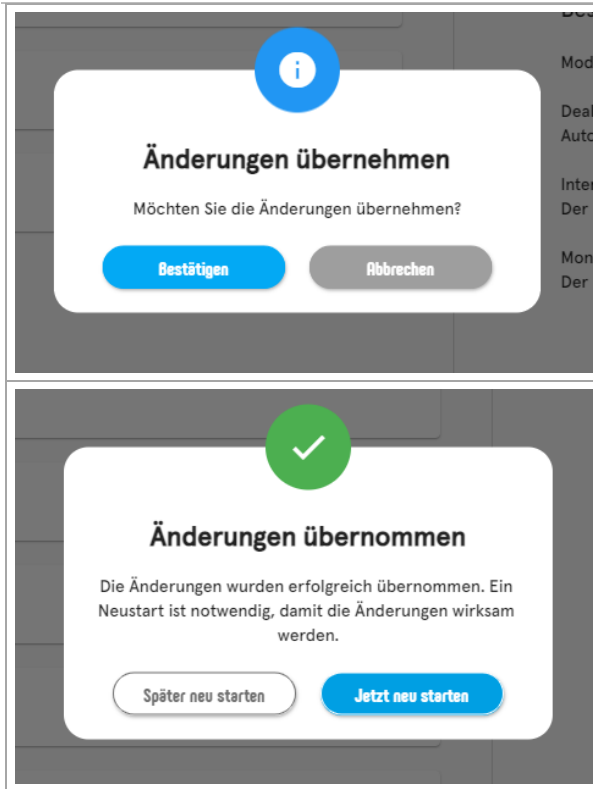

- The <Apply changes> button is displayed in the left column of the configuration.
- 8. Click the <Apply changes> button and follow the instructions.
- 9. Perform a restart.
- The changes are adopted.

6.4 DUCTO Guide

More information about DUCTO: https://www.compleo-cs.com/fileadmin/user_upload/downloads/solo/Ducto_Guide.pdf

6.5 Load management

Load management is set up when several charging systems are operated and parallel charging could lead to an overload of the grid connection. The charging systems are physically connected by means of a switch, which is either built into the charging system or set externally, and can communicate with each other. See chapter 5.5 Data connection cable , page 43.

Subsequently, settings are made in the DUCTO configuration software regarding the master and slave set-up in order to divide the available current between them according to set rules. See chapter 6.3 Configuration of the charging system with Compleo DUCTO, page 49and .

7 Operation

⚠ DANGER**Danger due to electric current**

Damage to the charging systems or components may expose live parts. Touching live parts will result in electric shock with serious injury or death.

- Only operate the charging system when it is undamaged.
- In the event of damage, immediately disconnect the charging system from the power supply at the circuit breaker and take suitable safety measures to prevent it from being switched on again.
- Work on electrical components may only be carried out by a qualified electrician.
- Repair work may only be carried out by the customer service.

Depending on the charging system and product scope, the following operating and authorisation forms for starting and ending a charging process are possible:

- Free charging
- RFID
- Giro-e/credit card
- App on smartphone/tablet or web interface

Free charging:

With the "Free charging" method, a charging process is started or stopped at a charging system without special authorisation. The charging process is started as soon as a charging cable has been connected to the charging system and/or the vehicle.

RFID:

With the "RFID" method, a charging process is started or stopped at a charging system using a card or chip. The charging process is started as soon as authorisation has been successfully completed and a charging cable has been connected to the charging system and/or the vehicle.

Giro-e:

With the "Giro-e" method, a charging process is started on a charging system by means of a Giro card and then confirmed or terminated. The charging process is started as soon as authorisation has been successfully completed and a charging cable has been connected to the vehicle.

App on smartphone/tablet or web interface:

With the "App on smartphone/tablet or web interface" method, a charging process is started or ended at a charging system by means of an application or a web interface. Depending on the authorisation type and provider, registration may be necessary. The charging process is started as soon as the charging system, charging point and tariff have been selected. The display complying with weights and measures regulations shows an ID number assigned to the charging process. Depending on the provider, billing may be via PayPal or invoice (different payment methods are possible). The charging

process is started as soon as a charging cable has been connected to the charging system and/or the vehicle.

Information on which app is necessary and how to operate the app should be obtained from the operator of the charging system.

7.1 Charging process





If no charging process has been started at the charging system, any one of the two charging points can be selected for a charging process.



- 1 Display
- 2 RFID field (also for authorisation via Giro card)
- 3 Status LEDs
- 4 Charging interface, socket type 2 (or attached cable with type 2 plug)

7.1.1 Meaning of the status LED colours

During the charging process, both the display and the status LEDs show the progress of the charging process.

Charging state display: LED colour state			
1.	LED: "grey"	The charging system indicates the standby state. <ul style="list-style-type: none"> • Authorisation can be carried out. 	
2.	LED: "green"	The charging system indicates readiness for operation. <ul style="list-style-type: none"> • A charging process can be started. 	
3.	LED: "blue"	The charging system indicates a charging process. <ul style="list-style-type: none"> • The charging process can be maintained or terminated. 	
4.	LED: "red"	The charging system indicates an error state. (not for RGB 2-colour) <ul style="list-style-type: none"> • A charging process cannot be started. 	

7.1.2 Authorisation

Depending on the configuration of the purchased charging system, the procedure for starting a charging process differs:

1. Plug & Charge
This involves charging the vehicle without authorisation.
2. Charging with authorisation
If an authorisation and/or payment transaction is required, the following authorisation/payment methods are available:

RFID card or RFID chip



1. Hold the RFID card or RFID chip in front of the RFID field.
 - The display and the status LED indicate readiness for operation.



Giro-e



1. Hold the Giro card in front of the RFID field.
 - The display shows the tariff conditions and the collection:
"Price: X.XX/Start + X.XX/kWh + X.XXX/min - collection
XXXXXXXX - Use card to agree."
2. Hold the Giro card again in front of the RFID field to agree to the conditions and the direct debit procedure.
 - The display and the status LED indicate readiness for operation.



App on smartphone/tablet or web interface



1. Download and install app for smartphone or tablet or start web interface.
2. Follow the instructions of the app or web interface for the authorisation process.
 - The display and the status LED indicate readiness for operation.



7.1.3 Connecting the charging cable

Before plugging in the charging cables, check that the status LED of the charging point is green.



Type 2 socket

1. Plug in the charging cable in the socket of the charging system.
2. Only then plug in the charging cable in the socket of the vehicle.



Type 2 plug with attached plug

1. Plug in the charging cable in the socket of the vehicle.

7.1.4 Starting the charging process

The charging process starts automatically after the existing authorisation method has been successfully carried out and the charging system and vehicle have been connected to the charging cable.

- The display and the status LED indicate the start of the charging process.



During charging, the plug is locked in the charging system and in the vehicle.

7.1.5 Ending the charging process

The charging process stops automatically after the existing authorisation method has been successfully executed again.

RFID card or RFID chip



1. Hold the RFID card or RFID chip in front of the RFID field.
 - The display and the status LED indicate the end of the charging process.



Giro-e



1. Hold the Giro card in front of the RFID field.
 - The display indicates the end of the charging process:
"Charged: XXX – Charging duration: XXX – SEPA".
 - The display and the status LED indicate the end of the charging process.



App on smartphone/tablet or web interface



1. Follow the instructions of the app or web interface for finishing the charging process.
 - The display and the status LED indicate the end of the charging process.



7.1.6 Disconnecting the charging cable

Type 2 socket



1. Pull out the charging cable from the socket of the vehicle.
2. Pull out the charging cable from the socket of the charging system.
 - The status LED no longer lights up.



Type 2 plug with attached plug



1. Pull out the charging cable from the socket of the vehicle.
 - The status LED no longer lights up.



7.1.7 Retrieve billing data



Giro-e

Within a period of 10 minutes after completion of a charging process, it is possible to display the SEPA ID by holding the Giro card in front of the RFID field again.

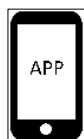





App on smartphone/tablet or web interface

All charging process data can be called up permanently via an individual link in the reason for payment note of the bank account statement. The essential information of the charging process is visible in the account statement.

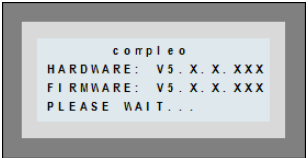
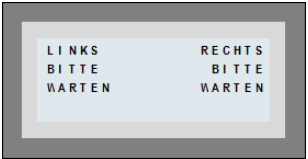
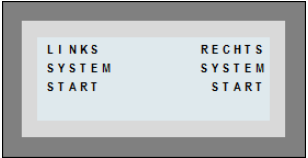
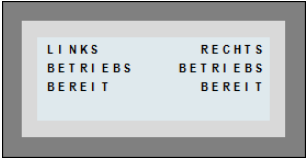
7.2 Operating Signals and Displays

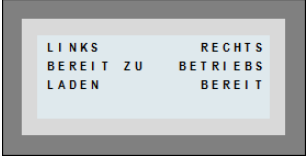



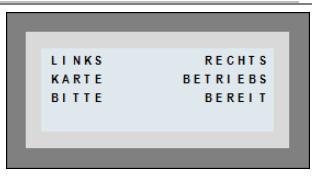
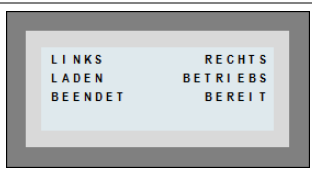
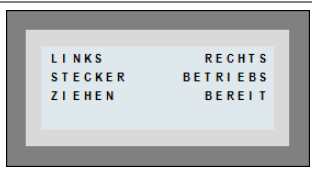
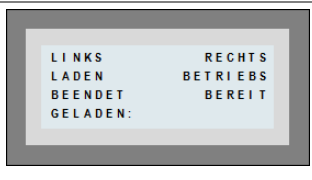
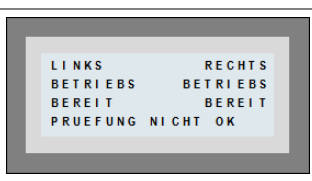
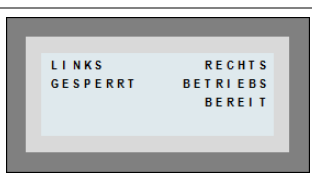
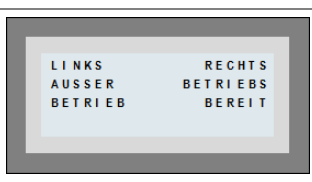
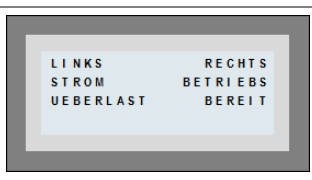







Depending on type and configuration, the charging systems have the ability to output states, processes or errors via a display and/or LEDs. Depending on the type, configuration and the number of charger interfaces of the charging system, the type of representations on the display and/or the colour of the LEDs may differ.

Message display:		
1.	<p>The charging system indicates the “compleo + hardware: + Firmware + Please wait” state.</p> <ul style="list-style-type: none"> The hardware version is displayed. The firmware version is displayed. Initialisation is being prepared. 	
2.	<p>The charging system indicates the “Please wait” state.</p> <ul style="list-style-type: none"> The charging system processes data. It takes time to start an action, e.g. an authorisation process. 	
3.	<p>The charging system indicates the “System start” state.</p> <ul style="list-style-type: none"> The charging system starts the system. It takes some time to start an action, e.g. starting a charging process. 	
4.	<p>The charging system indicates the “Ready for operation” state.</p> <ul style="list-style-type: none"> The charger interface is ready for operation. A charging process can be started. 	
5.	<p>The charging system indicates the “Plug in plug” + “Check OK” state.</p> <ul style="list-style-type: none"> A charging process is to be started, the charging cable should be plugged into the charging system and/or the vehicle. 	
6.	<p>The charging system indicates the “Wait for vehicle” state.</p> <ul style="list-style-type: none"> A charging process is to be started and communication with the vehicle is in progress. 	
7.	<p>The charging system indicates the “Ready to charge” state.</p> <ul style="list-style-type: none"> A charging process is to be started, communication was successful. 	
8.	<p>The charging system indicates the “Charge” state.</p> <ul style="list-style-type: none"> The charger interface is functional and a charging process is performed. 	

9.	<p>The charging system indicates the “Please insert card” state.</p> <ul style="list-style-type: none"> A charging process is to be started, the RFID card or chip is required. 	
10.	<p>The charging system indicates the “Charging finished” state.</p> <ul style="list-style-type: none"> A charging process was correctly completed. 	
11.	<p>The charging system indicates the “Pull out plug” state.</p> <ul style="list-style-type: none"> A charging process was terminated, the charging cable should be pulled out at the charging system and/or the vehicle. 	
12.	<p>The charging system indicates the “Charging finished + charged” state.</p> <ul style="list-style-type: none"> A charging process was correctly completed. The charged capacity is displayed. 	
13.	<p>The charging system indicates the “Ready for operation + check not OK” state.</p> <ul style="list-style-type: none"> The charger interface is ready for operation, but the authorisation process was not successful. 	
14.	<p>The charging system indicates the “Disabled” state.</p> <ul style="list-style-type: none"> The charger interface is disabled. A charging process cannot be started. 	
15.	<p>The charging system indicates the “Out of service” state.</p> <ul style="list-style-type: none"> The charger interface is out of service, an error has occurred and no charging process can be started. 	
16.	<p>The charging system indicates the “Current overload” state.</p> <ul style="list-style-type: none"> The charger interface is out of service, an overcurrent has occurred and the charging process has been interrupted. 	

Operation

The following charging state display explains the colour states and the possible colour changes of a charging system with status LEDs:

Charging state display: LED colour state			
1.	LED: "grey"	The charging system indicates the standby state. <ul style="list-style-type: none"> • Authorisation can be carried out. 	
2.	LED: "green"	The charging system indicates readiness for operation. <ul style="list-style-type: none"> • A charging process can be started. 	
3.	LED: "blue"	The charging system indicates a charging process. <ul style="list-style-type: none"> • The charging process can be maintained or terminated. 	
4.	LED: "red"	The charging system indicates an error state. (not for RGB 2-colour) <ul style="list-style-type: none"> • A charging process cannot be started. 	
Charging state display: LED colour change			
5.	LED: "grey-green"	The charging system indicates an authorisation process.	
6.	LED: "grey-red"	The charging system indicates an error before a charging process. (not for RGB 2-colour)	
7.	LED: "green-grey"	The charging system indicates unsuccessful authorisation.	
8.	LED: "green-blue"	The charging system indicates the start of a charging process.	
9.	LED: "green-red"	The charging system indicates an error before successful authorisation. (not for RGB 2-colour)	
10.	LED: "blue-grey"	The charging system indicates a voltage drop after starting a charging process.	
11.	LED: "blue-green"	The charging system indicates the end of a charging process.	
12.	LED: "blue-red"	The charging system indicates an error after starting a charging process. (not for RGB 2-colour)	

8 Error display and measures

The charging system displays an error code on the display in case of errors.

If several errors occur at the same time or in combination, the respective error codes are shown one after the other on the display.

Basically, a distinction is made between ErrorStatus and ErrorEvents.

- An ErrorStatus is an error that occurs and persists until it is corrected.
- An ErrorEvent is an error event that occurs once and then again.

8.1 Error status

NOTE

The display indication is shown in brackets () after the error heading.

8.1.1 EVCommunicationError (A)

Name	EVCommunicationError
Area	Connector
Description	<p>OCPP1.6: "Communication failure with the vehicle, might be Mode 3 or other communication protocol problem. This is not a real error in the sense that the Charge Point doesn't need to go to the faulted state. Instead, it should go to the SuspendedEVSE state."</p> <p>AC: A mode 3 communication problem cannot be detected.</p> <p>DC: Detection of a communication problem between EVSE and EV is possible, but not explicitly performed.</p>
Reported by:	Connector
Handling	<ul style="list-style-type: none"> • The error is shown on the display
Indication on display	A

8.1.2 GroundFailure (B)

Name	GroundFailure
Area	Connector (AC/ DC)
Description	<p>OCPP1.6: Ground fault circuit interrupter has been activated. The RCD switch, the circuit breaker or the 6mA sensor of the connector has tripped, protective function.</p>
Reported by:	Station
Handling	<ul style="list-style-type: none"> • The error is shown on the display
Indication on display	B

Error display and measures

Cause/measure	Check the RCD switch for the corresponding connector on site and have it switched on by a qualified electrician if necessary. Alternatively, report the fault to the hotline.
---------------	---

8.1.3 HighTemperature (C)

Name	HighTemperature
Area	Station
Description	OCPP1.6: Temperature inside Charge Point is too high. Temperature inside Charge Point is too high.
Reported by:	Station
Handling	<ul style="list-style-type: none"> The error is shown on the display
Indication on display	C

8.1.4 InternalError (D)

Name	InternalError
Area	Station
Description	OCPP1.6: Error in internal hardware or software component. For example, errors during initialisation of the socket module.
Reported by:	Connector
Handling	<ul style="list-style-type: none"> The connector terminates the charging process The error is shown on the display
Indication on display	D
Cause/measure	Collective message for non-specific internal error states. Send hard reset to the station. If the error message is sent again, report the fault to the hotline.

8.1.5 OverVoltage (E)

Name	OverVoltage
Area	Connector (AC)
Description	OCPP1.6: Voltage has risen above an acceptable level. The temperature of the connector exceeds the permissible value.
Reported by:	Connector
Handling	<ul style="list-style-type: none"> The error is shown on the display
Indication on display	E

8.1.6 PowerMeterFailure (F)

Name	PowerMeterFailure
Area	Connector (AC)
Description	OCPP1.6: Failure to read electrical/energy/power meter.
Reported by:	Connector
Handling	· The error is shown on the display
Indication on display	F

8.1.7 PowerSwitchFailure (G)

Name	PowerSwitchFailure
Area	Connector (AC/ DC)
Description	OCPP1.6: Failure to control power switch.
Reported by:	Connector
Handling	· The error is shown on the display
Indication on display	G
Cause/measure	Error when switching the contactor. If the error persists for a longer period of time or occurs during every charging process, report the fault to the hotline. The contactor must then be checked by a service call and replaced if necessary.

8.1.8 ReaderFailure (H)

Name	ReaderFailure
Area	Connector (AC/ DC)
Description	OCPP1.6: Failure with idTag reader.
Reported by:	Connector
Handling	· The error is shown on the display
Indication on display	H

8.1.9 UnderVoltage (I)

Name	UnderVoltage
Area	Connector
Description	OCPP1.6: Voltage has dropped below an acceptable level.
Reported by:	Connector

Error display and measures

Handling	<ul style="list-style-type: none"> • The connector terminates the charging process • The error is shown on the display
Indication on display	I
Cause/measure	At least one phase voltage is missing at the corresponding connector at the input of the electricity meter. Have the current path from the feed to the electricity meter checked by a qualified electrician or report the fault to the hotline.

8.1.10 WeakSignal (J)

Name	WeakSignal
Area	Station
Description	OCP1.6: Wireless communication device reports a weak signal.
Reported by:	Station
Handling	<ul style="list-style-type: none"> • The error is shown on the display
Indication on display	J

8.2 Compleo-specific error status

8.2.1 IsolationWarning (K)

Name	IsolationWarning
Area	Connector (DC), connector (AC) + 15118
Description	The error occurs with isolation problems before and during a 15118 charging process.
Reported by:	Connector
Handling	<ul style="list-style-type: none"> The error is shown on the display
Indication on display	K

8.2.2 IsolationError (L)

Name	IsolationError
Area	Connector
Description	The error occurs with isolation problems before and during a 15118 charging process.
Reported by:	Connector
Handling	<ul style="list-style-type: none"> The error is shown on the display
Indication on display	L

8.2.3 DoorOpen (M)

Name	DoorOpen
Area	Station
Description	The door contact signals that the door has been opened.
Reported by:	Station
Handling	<ul style="list-style-type: none"> The error is shown on the display If necessary, further actions, e.g. cancellation of an ongoing charging process
Indication on display	M

8.2.4 DoorClosed (N)

Name	DoorClosed
Area	Station
Description	The door contact signals that the door has been closed.
Reported by:	Station

Error display and measures

Handling	<ul style="list-style-type: none"> The error is shown on the display
Indication on display	N

8.2.5 Inoperative (O)

Name	Inoperative
Area	Connector
Description	The error occurs when a connector is not available because a resource (e.g. the power module) is occupied by another connector.
Reported by:	Connector
Handling	<ul style="list-style-type: none"> The connector is reported as "Unavailable" to the communicator The error is shown on the display
Indication on display	O

8.2.6 FuseError (P)

Name	FuseError
Area	Connector (AC)
Description	The error occurs when a circuit breaker trips.
Reported by:	Connector
Handling	<ul style="list-style-type: none"> The error is shown on the display The connector is taken "out of service" No new charging process can be started If a charging process is in progress, it is terminated by the connector
Indication on display	P

8.2.7 TemperatureSensorMissing (Q)

Name	TemperatureSensorMissing
Area	Connector
Description	The error occurs when none of the temperature sensors provide a value.
Reported by:	Connector
Handling	<ul style="list-style-type: none"> The error is shown on the display The maximum charging current is lowered
Indication on display	Q

8.2.8 TemperatureSensorHighLimitViolation (R)

Name	TemperatureSensorHighLimitViolation
Area	Connector
Description	The error occurs when the temperature sensor delivers values outside its valid range (> 80 °C).
Reported by:	Connector
Handling	<ul style="list-style-type: none"> • The error is shown on the display • The maximum charging current is lowered
Indication on display	R

8.2.9 TemperatureSensorLowLimitViolation (S)

Name	TemperatureSensorLowLimitViolation
Area	Connector
Description	The error occurs when the temperature sensor delivers values outside its valid range (< -30 °C).
Reported by:	Connector
Handling	<ul style="list-style-type: none"> • The error is shown on the display • The maximum charging current is lowered
Indication on display	S

8.2.10 AutomaticRcdTestRunning (T)
NOTE

Error/status can be sent if the optOcppSendVSSNFiReset option is set.

Name	AutomaticRcdTestRunning
Area	Station
Description	An automatic RCD switch test is running (no 6mA sensor test). The RCD switch test is only carried out when no charging process is active.
Reported by:	Station
Handling	<ul style="list-style-type: none"> • The error is shown on the display
Indication on display	T

Error display and measures

Cause/measure	<p>Status message/display, no action necessary serves as information. Charging stations that have installed RCD switches that can be switched on again can carry out cyclical self-tests (tripping/reconnection) if they are configured accordingly.</p> <p>During this test time, the charging point is not available and the status is set to indicate the cause. If this status is not reset within a few minutes or replaced by a corresponding error message from the RCD, have the RCD switch with motor unit checked by a qualified electrician or report the fault to the hotline. In the case of stations compliant with the German standard Weights and Measures Law, clarify with the hotline whether the RCDs are in the circuit compliant with the German standard Weights and Measures Law; then only approved repairers may carry out changes to the RCDs.</p>
---------------	---

8.2.11 AutomaticRcdTestFailed (U)

Name	AutomaticRcdTestFailed
Area	Connector
Description	The automatic test of the RCD was successful.
Reported by:	Connector
Handling	· The error is shown on the display
Indication on display	U

8.2.12 RCSensorTestRunning (W)

Name	RCSensorTestRunning
Area	Connector (AC)
Description	The error occurs while a test of the 6mA sensors is in progress. This test is only carried out when no charging process is active.
Reported by:	Connector
Handling	· The error is shown on the display
Indication on display	W
Cause/measure	<p>Status message/display, no action necessary serves as information. Only report the fault to the hotline if the status is permanent and is not reset by a hard reset. In the case of stations compliant with the German standard Weights and Measures Law, clarify with the hotline whether the 6mA sensor is in the circuit compliant with the German standard Weights and Measures Law; then only approved repairers may carry out changes.</p>

8.2.13 DcPsuConnectionFailure (X)

Name	DcPsuConnectionFailure
------	------------------------

Area	Station (DC)
Description	The error occurs in DC stations with separate power and control unit. If the error occurs, there is a communication problem between the CCU board in the control unit and the PSU board in the power unit.
Reported by:	Station
Handling	<ul style="list-style-type: none"> • The error is shown on the display • Running DC-LV is terminated
Indication on display	X
Cause/measure	If this status is detected and reported and is permanently present, send a hard reset and/or switch the complete station off/on on-site. If the error continues to be sent, report it to the hotline. On-site use by service necessary.

8.2.14 DcInsulationCodeWarning (Y)

Name	DcInsulationCodeWarning
Area	Connector (DC)
Description	An insulation warning has occurred during a DC charging process. (Status)
Reported by:	Connector
Handling	<ul style="list-style-type: none"> • The error is shown on the display
Indication on display	Y

8.2.15 DcInsulationCodeFault (Z)

Name	DcInsulationCodeFault
Area	Connector (DC)
Description	An insulation error has occurred during a DC charging process. (Status)
Reported by:	Connector
Handling	<ul style="list-style-type: none"> • The charging process is aborted • The error is shown on the display
Indication on display	Z

8.2.16 DcInsulationCodeInvalid (1)

Name	DcInsulationCodeInvalid
Area	Connector (DC)
Description	An invalid insulation status has occurred during a DC charging process. (Status)

Error display and measures

Reported by:	Connector
Handling	<ul style="list-style-type: none"> • The charging process is aborted • The error is shown on the display
Indication on display	1

8.2.17 DcInsulationTestFailureOnStart (2)

Name	DcInsulationTestFailureOnStart
Area	Connector (DC)
Description	The insulation test at the start of the charging process has found an error.
Reported by:	Connector
Handling	<ul style="list-style-type: none"> • The charging process is aborted • The error is shown on the display
Indication on display	2

8.2.18 DcInsulationTestFailureOnCharge (3)

Name	DcInsulationTestFailureOnCharge
Area	Connector (DC)
Description	The insulation test during the charging process has found an error.
Reported by:	Connector
Handling	<ul style="list-style-type: none"> • The charging process is aborted • The error is shown on the display
Indication on display	2

8.2.19 samTransactionMemoryFull (4)

Name	samTransactionMemoryFull
Area	Connector
Description	The error occurs when the SAM has no more free memory for new charging processes.
Reported by:	SAMConnector
Handling	<ul style="list-style-type: none"> • The charging process is aborted • The error is shown on the display • No new charging process possible
Indication on display	4

Cause/measure	The German standard Weights and Measures Law stipulates this internal buffer memory in order to enable the customer to check it retrospectively. If the memory is full, this status is communicated. The SAM module must then be replaced by authorised/approved personnel as part of a repair compliant with the German standard Weights and Measures Law. Report the case to the hotline, no solution possible by the operator.
---------------	---

8.2.20 samEVSEIDMemoryFull (5)

Name	samEVSEIDMemoryFull
Area	Connector
Description	The error occurs when the SAM has no more free memory for new configuration parameters.
Reported by:	Connector
Handling	<ul style="list-style-type: none"> · The charging process is aborted · The error is shown on the display · No new charging process possible
Indication on display	5
Cause/measure	The German standard Weights and Measures Law stipulates this internal buffer memory to enable the operator to change EVSEIDs. If the memory is full, this status is communicated. The SAM module must then be replaced by authorised/approved personnel as part of a repair compliant with the German standard Weights and Measures Law. Report the case to the hotline, no solution possible by the operator.

8.2.21 samFirmwareCorrupted (6)

Name	samFirmwareCorrupted
Area	Connector
Description	The SAM firmware checksum check failed. This can also occur during operation, as the firmware checksum is checked regularly.
Reported by:	SAMAdapter
Handling	<ul style="list-style-type: none"> · The charging process is aborted · The error is shown on the display · No new charging process possible
Indication on display	6
Cause/measure	The SAM module must then be replaced by authorised/approved personnel as part of a repair compliant with the German standard Weights and Measures Law. Report the case to the hotline, no solution possible by the operator.

8.2.22 samNoTouchControllerComm (7)

Name	samNoTouchControllerComm
Area	Connector
Description	The connection between SAM and the touch keys for SAM query is disturbed.
Reported by:	SAMAdapter
Handling	<ul style="list-style-type: none"> · The charging process is aborted · The error is shown on the display · No new charging process possible
Indication on display	7
Cause/measure	The touch controller unit must be replaced by the manufacturer without interfering with the load circuit in compliance with the German standard Weights and Measures Law. Inform the hotline and commission the assignment.

8.2.23 samNotInitialized (8)

Name	samNotInitialized
Area	Connector
Description	The SAM could not be initialised because, for example, the connection between the SAM and the control unit is defective.
Reported by:	SAMAdapter
Handling	<ul style="list-style-type: none"> · The error is shown on the display
Indication on display	8
Cause/measure	Hard reset and/or switch off/on on-site. If the error continues to be sent, report it to the hotline. The SAM module must then be replaced by authorised/approved personnel as part of a repair compliant with the German standard Weights and Measures Law. No solution possible by the operator.

8.2.24 samInternalError (9)

Name	samInternalError
Area	Connector
Description	The SAM reports an internal error.
Reported by:	SAMAdapter
Handling	<ul style="list-style-type: none"> · New charging processes cannot be started · The error is shown on the display
Indication on display	9

Cause/measure	Hard reset and/or switch off/on on-site. If the error continues to be sent, report it to the hotline. The SAM module must then be replaced by authorised/approved personnel as part of a repair compliant with the German standard Weights and Measures Law. No solution possible by the operator.
---------------	--

8.2.25 UnlockPlugFailure (a)

Name	UnlockPlugFailure
Area	Connector
Description	The plug could not be unlocked.
Reported by:	Connector
Handling	<ul style="list-style-type: none"> • New charging processes cannot be started • The error is shown on the display
Indication on display	a

8.2.26 OutletCloseError (b)

Name	OutletCloseError
Area	Connector
Description	The socket could not be closed (error when closing or locking the sliding cover).
Reported by:	Connector
Handling	<ul style="list-style-type: none"> • New charging processes cannot be started • The error is shown on the display
Indication on display	b

8.2.27 LPCCommunicationError (c)

Name	LPCCommunicationError
Area	Connector
Description	There is an error in the communication between the charging point controller and the Linux application (CCS).
Reported by:	Connector
Handling	<ul style="list-style-type: none"> • New charging processes cannot be started • The error is shown on the display
Indication on display	c

Error display and measures

8.2.28 CableError (d)

Name	CableError
Area	Connector
Description	An unauthorised charging cable has been detected (13 A cable or undefined cable).
Reported by:	Connector
Handling	<ul style="list-style-type: none"> • Charging cannot be started with this cable • The error is shown on the display
Indication on display	d

8.2.29 RCSensorTestError (e)

Name	RCSensorTestError
Area	Connector
Description	The test of the 6mA sensor was not successful.
Reported by:	Connector
Handling	<ul style="list-style-type: none"> • New charging processes cannot be started • The error is shown on the display
Indication on display	e

8.2.30 PowerMonitoringError (f)

Name	PowerMonitoringError
Area	Connector
Description	The charging point controller has detected a mains failure.
Reported by:	Connector
Handling	<ul style="list-style-type: none"> • New charging processes cannot be started • The error is shown on the display
Indication on display	f

8.2.31 ADCError (g)

Name	ADCError
Area	Connector
Description	The charging point controller has detected an ADC error.
Reported by:	Connector
Handling	<ul style="list-style-type: none"> · New charging processes cannot be started · The error is shown on the display
Indication on display	g

8.2.32 ShortCircuitError (h)

Name	ShortCircuitError
Area	Connector
Description	The charging point controller has detected a short circuit between CP and PE.
Reported by:	Connector
Handling	<ul style="list-style-type: none"> · New charging processes cannot be started · The error is shown on the display
Indication on display	h

8.2.33 LPCOverVoltageError (i)

Name	LPCOverVoltageError
Area	Connector
Description	The charging point controller has detected an overvoltage.
Reported by:	Connector
Handling	<ul style="list-style-type: none"> · New charging processes cannot be started · The error is shown on the display
Indication on display	i

Error display and measures**8.2.34 LPCHighTemperatureError (j)**

Name	LPCHighTemperatureError
Area	Connector
Description	The charging point controller has detected a temperature that is too high.
Reported by:	Connector
Handling	<ul style="list-style-type: none">• New charging processes cannot be started• The error is shown on the display
Indication on display	j

8.2.35 LPCSelftestError (k)

Name	LPCSelftestError
Area	Connector
Description	The self-test of the charging point controller has failed.
Reported by:	Connector
Handling	<ul style="list-style-type: none">• New charging processes cannot be started• The error is shown on the display
Indication on display	k

8.3 Error events

8.3.1 AutomaticRcdTestResetFailure ()

Name	AutomaticRcdTestResetFailure
Area	Connector
Description	The error occurs if the RCD that can be switched back on can no longer be reset during a cyclical test.
Reported by:	Connector
Handling	<ul style="list-style-type: none"> • Connector not available • The error is shown on the display
Indication on display	

8.3.2 ResetFailure ()

Name	ResetFailure
Area	Connector
Description	OCPP1.6: Unable to perform a reset
Reported by:	Connector
Handling	<ul style="list-style-type: none"> • The error is shown on the display
Indication on display	

8.3.3 AutomaticRcdTestSuccess ()

Name	AutomaticRcdTestSuccess
Area	Connector
Description	The status occurs when the cyclic automatic RCD test was successful.
Reported by:	Connector
Handling	<ul style="list-style-type: none"> • The status is sent to the communicator and then reset
Indication on display	

8.3.4 AutomaticRcdTestTripFailure ()

Name	AutomaticRcdTestTripFailure
Area	Connector
Description	The error occurs if the RCD switch does not trip during the cyclical automatic RCD test.
Reported by:	Connector
Handling	<ul style="list-style-type: none"> • Connector not available • The error is shown on the display
Indication on display	

8.3.5 AutomaticRcdResetContactorTestFailed ()

Name	AutomaticRcdResetContactorTestFailed
Area	Connector
Description	The error occurs if the cause of the RCD error is not eliminated after the RCD has tripped and automatically switched on after the test. The charging process was terminated by the error.
Reported by:	Connector
Handling	<ul style="list-style-type: none"> • Connector not available • The error is shown on the display
Indication on display	

8.3.6 AutomaticRcdResetSuccess ()

Name	AutomaticRcdResetSuccess
Area	Connector
Description	The error occurs if the cause of the RCD error is eliminated after the RCD has tripped and automatically switched on after the test.
Reported by:	Connector
Handling	<ul style="list-style-type: none"> • The status is sent to the communicator and then reset
Indication on display	

8.3.7 AutomaticRcdResetSwitchOnFailed ()

Name	AutomaticRcdResetSwitchOnFailed
Area	Connector
Description	The error occurs if the cause of the RCD error is eliminated after the RCD has tripped and automatically switched on after the test.
Reported by:	Connector
Handling	<ul style="list-style-type: none"> The error is shown on the display
Indication on display	

8.3.8 AutomaticRcdResetContactorTestFailed ()

Name	AutomaticRcdResetContactorTestFailed
Area	Connector
Description	
Reported by:	Connector
Handling	
Indication on display	

8.3.9 ConnectorLockFailure ()
NOTE

This is a standard OCPP1.6 error.

Name	ConnectorLockFailure
Area	Connector (AC)
Description	An error occurred when trying to lock or unlock the plug at the AC charging point at the charging station. The charging process could therefore not be started. This is an error event, as it can happen that the customer has not plugged in the connector correctly. Afterwards, the customer or even the next customer can start a new charging process without any problems. (OCPP1.6 spec: "Failure to lock or unlock connector.")
Reported by:	Connector
Handling	<ul style="list-style-type: none"> Cancel the start of the charging process The error is not shown in the display StatusNotification
Indication on display	

Error display and measures

Cause/measure	By repeating the charging process, the error should not occur again. The cause is normally the operation by the customer. However, if a new charging process is permanently not possible without this error, have the locking unit at the AC charging point checked or report it to the hotline. In this case, the locking unit must be replaced.
---------------	---

8.3.10 DriveError ()

Name	DriveError
Area	Connector (AC)
Description	The error occurs when the movable socket procedure does not work.
Reported by:	Connector
Handling	· The error is shown on the display
Indication on display	

8.3.11 LastGasp ()

Name	LastGasp
Area	Station
Description	The error occurs when the power supply fails. The prerequisite is that a buffer capacitor is installed and the voltage monitoring input on the SoC changes from high to low.
Reported by:	Station
Handling	· The error is shown on the display
Indication on display	

8.3.12 McuReset ()

Name	McuReset
Area	Connector
Description	The error occurs when a charging point controller is reset. The configuration option optOcppVendorErrorCode42002AEnabled must be set.
Reported by:	Connector
Handling	· The error is shown on the display
Indication on display	

8.3.13 OutletOpenError ()

Name	OutletOpenError
Area	Connector (AC)
Description	The error occurs when the opening of the socket does not work.
Reported by:	Connector
Handling	<ul style="list-style-type: none"> • The error is shown on the display • The charging process cannot be started
Indication on display	

8.3.14 OverCurrentFailure ()
NOTE

This is a standard OCPP1.6 error.

Name	OverCurrentFailure
Area	Connector (AC)
Description	The overcurrent detection was triggered because the vehicle drew more current over a longer period of time than it was given via the PWM specification. (OCPP1.6: "Over current protection device has tripped")
Reported by:	Connector
Handling	<ul style="list-style-type: none"> • The error is not shown in the display • The charging process is aborted • StatusNotification
Indication on display	
Cause/measure	During AC charging, the charging station signals the maximum permissible current per phase to the car. If the car does not adhere to this specification, the overcurrent monitoring detects this condition and terminates the charging process with a time delay depending on the % exceeding the specification. This is not a fault of the station. No further action required.

8.3.15 RCSensorErrorDuringCharge ()

Name	RCSensorErrorDuringCharge
Area	Connector (AC)
Description	The error occurs when the 6mA sensor trips during the charging process.
Reported by:	Connector
Handling	<ul style="list-style-type: none"> • The error is shown on the display • The charging process is aborted
Indication on display	

8.3.16 RCSensorNoError ()

Name	RCSensorNoError
Area	Connector (AC)
Description	The error occurs when there is no 6mA sensor error.
Reported by:	Connector
Handling	<ul style="list-style-type: none"> • The error is shown on the display
Indication on display	

8.3.17 RCSensorTestOk ()

Name	RCSensorNoError
Area	Connector (AC)
Description	The error occurs when the 6mA sensor test was successful.
Reported by:	Connector
Handling	
Indication on display	

8.3.18 RCSensorTestError ()

Name	RCSensorTestError
Area	Connector (AC)
Description	The error occurs when the 6mA sensor test was unsuccessful.
Reported by:	Connector
Handling	<ul style="list-style-type: none">• The error is displayed• No charging process can be started.
Indication on display	

9 Malfunctions

9.1 Internal errors

- If the display shows "Internal error", the charging station must be disconnected from the mains.

9.2 Residual current circuit breaker (RCCB)

In the event of a residual current, the residual current circuit breaker trips and the charging system is switched off.

To switch on again, proceed as follows:

1. Eliminate the cause of the error.
2. Activate the residual current circuit breaker by pushing up the toggle switch.

The system starts up.

NOTE

Only applies to charging systems with built-in residual current circuit breaker (RCCB).

9.3 Circuit breaker (MCB)

In the event of an overcurrent, the affected circuit breaker trips and the charging system is switched off.

To switch on again, proceed as follows:

1. Eliminate the cause of the error.
2. Reactivate the circuit breaker at the sub-distribution.

The system starts up.

10 Error display and measures

The charging system displays an error code on the display in case of errors.

If several errors occur at the same time or in combination, the respective error codes are shown one after the other on the display.

Basically, a distinction is made between ErrorStatus and ErrorEvents.

- An ErrorStatus is an error that occurs and persists until it is corrected.
- An ErrorEvent is an error event that occurs once and then again.

10.1 About this advices

Column name	Explanation
Title	String sent to the backend when the charging station is in online mode.
Code	Symbol that is shown individually or in combination with other symbols on the charging station display depending on the status.
Troubleshooting advice	Description of the fault and troubleshooting advice.

10.1.1 Field of application

Firmware 5.X and 6.X (SOLO, DUO, CITO)

10.2 OCPP 1.6

Title	Code	Troubleshooting advice
GroundFailure	B	The RCD, the circuit breaker or the 6mA sensor of the charging point has tripped. Inspection by qualified electrician required.
InternalError	D	Error in internal hardware or software component. Inspection by qualified electrician required.
OverVoltage	E	The voltage has risen above an acceptable level. Inspection by qualified electrician required.
PowerMeterFailure	F	Error when reading the meter. Check SAM or meter for function and report fault.
PowerSwitchFailure	G	Contactora fault. Inspection by qualified electrician required.
UnderVoltage	I	The voltage has dropped below an acceptable level. Inspection by qualified electrician required.

Error display and measures

ConnectorLockFailure	-	Error when locking or unlocking the plug. It must be checked whether the plug is connected correctly.
OverCurrentFailure	-	The vehicle has drawn more current than specified for an extended period of time.

Not used: EVCommunicationError, HighTemperature, ReaderFailure, WeakSignal

10.3 Compleo-specific

Title	Code	Troubleshooting advice
IsolationWarning	K	Insulation problems occurred before or during a charging process. Inspection by qualified electrician required.
IsolationError	L	Insulation problems occurred before or during a charging process. Inspection by qualified electrician required.
DoorOpen	M	The door contact signals that the door has been opened. Close door. If this condition is permanent, a test by a qualified electrician is required.
DoorClosed	N	The door contact signals that the door has been closed. No action required.
Inoperative	O	The charging point is not available because a resource, such as the power module, is occupied by another charging point. Inspection by qualified electrician required.
FuseError	P	A circuit breaker has tripped. Inspection by qualified electrician required.
TemperatureSensorMissing	Q	The temperature sensor does not provide any values. Inspection by qualified electrician required.
AutomaticRcdTestRunning	T	Automatic test of the RCD is running. No action required.
RCSensorTestRunning	W	Test of the 6mA sensor test in progress. No action required.

Error display and measures

samTransactionMemoryFull	4	SAM has no more free memory for new charging processes. SAM must be replaced by an authorized electrician.
samEVSEIDMemoryFull	5	SAM has no more free memory for new configuration parameters. SAM must be replaced by an authorized electrician.
samFirmwareCorrupted	6	The SAM firmware checksum check has failed. If this condition is permanent, SAM must be replaced by an authorized electrician.
samNoTouchControllerComm	7	The connection to the SAM keys is disturbed. Check by qualified electrician required. If this condition is permanent, SAM must be replaced by an authorized electrician.
samNotInitialized	8	SAM could not be initialized. If this condition is permanent, SAM must be replaced by an authorized electrician.
samInternalError	9	SAM reports an internal error. SAM must be replaced by an authorized electrician.
UnlockPlugFailure	a	The plug could not be unlocked. The locking unit of the charging point must be checked by trained personnel and replaced if necessary.
OutletCloseError	b	The sliding lid could not be closed. The locking unit of the sliding lid must be checked by trained personnel and replaced if necessary.
LPCCommunicationError	c	The communication between the charging point controller and the charging station controller is disturbed. The corresponding connection must be checked by trained personnel and replaced if necessary.
CableError	d	A non-approved charging cable has been detected. A different charging cable must be used.
RCSensorTestError	e	The test of the 6mA sensor has failed. Inspection by qualified electrician required.
PowerMonitoringError	f	The charge point controller has detected a power failure. Inspection by a qualified electrician is required.
ADCErrror	g	The charge point controller has detected an ADC error. Inspection by qualified electrician required.

ShortCircuitError	h	The charge point controller has detected a short circuit between CP and PE. Inspection by qualified electrician required.
LPCOverVoltageError	i	The charge point controller has detected an overvoltage. Inspection by qualified electrician required.
LPCHighTemperatureError	j	The charging point controller has detected a temperature that is too high. Inspection by qualified electrician required.
LPCSelftestError	k	The self-test of the charging point controller has failed. Inspection by qualified electrician required.
AutomaticRcdTestFailed	m	The automatic test of the RCD has failed. Inspection by qualified electrician required.
LPCTemperatureSensorError	n	The charging point controller reports a temperature sensor error. Replacement by qualified electrician required.
CurrentSensorFailure	o	The charging point controller reports a current sensor error. Inspection by qualified electrician required.
PolarityProtectionError	p	The charging point controller reports that the phases are connected with reversed polarity. Inspection by qualified electrician required.
samCompensationsParameters Mismatch	q	Compensation parameters in SAM and in meter do not match. Inspection by authorized electrician required.
samCompensationTariff Mismatch	r	Selected tariff in the meter does not correspond to that which the meter reports as active. Inspection by authorized electrician required.
samMeterIdMismatch	s	The SML ID of the connected meter does not correspond to that of the meter connected to the SAM. Inspection by authorized electrician required.
AutomaticRcdTestSuccess	-	Automatic test of the RCD successful. No action required.
AutomaticRcdTestTripFailure	-	Automatic test of the residual current circuit breaker failed. Inspection by qualified electrician required.
AutomaticRcdReset ContactorTestFailed	-	The cause of the failed RCD test has not been eliminated. Inspection by qualified electrician required.

Error display and measures

AutomaticRcdResetSuccess	-	The cause of the failed test of the RCD has been eliminated. No action required.
OutletOpenError	-	The socket could not be opened. Inspection by qualified electrician required.
RCSensorErrorDuringCharge	-	The 6mA sensor has tripped during a charging process. Inspection by qualified electrician required if the error occurs frequently.

11 Maintenance

Careful and regular maintenance ensures that the functional condition of the charging system is maintained. Only a regularly checked and maintained charging system is able to guarantee maximum availability and reliable charging processes.

The maintenance intervals depend on the prevailing operating conditions, such as the frequency of use and environmental influences such as the degree of contamination.

We recommend a cyclically recurring inspection according to the maintenance plan. In special cases, the cycles can be shorter.

⚠ DANGER**Danger due to electric current**

Touching live parts will result in electric shock with serious injury or death.

- Work on electrical components may only be carried out by a qualified electrician and in accordance with electrical engineering rules.
 - Ensure they are de-energised and take suitable protective measures.
-

⚠ WARNING**Danger due to improper maintenance**

Improper performance of work can lead to serious injuries and damage to property.

- Work may only be carried out by trained specialist personnel.
 - Meet all safety requirements before maintenance.
-

11.1 Maintenance plan

Interval	Component/location	Maintenance work
Every 6 months	Residual current circuit breaker	Check with test button.
	Surge arrester	Visual inspection or check with test button.
Yearly	Location	Visual inspection, e.g. for distances to objects (bushes, electrical installations ,etc.), attachment.
	Electrical components	Visual inspection, e.g. cables, lines, screw connections, plugs, RCD, MCB, display, LED, display, surge protection.
		Metrological verification according to test report, see Annex.
		Check for function, e.g. RCD (test button), MCB, IMD.
	Mechanical components	Visual inspection, e.g. housing, paint, foils, covers.
		Check for function, e.g. door and closing mechanism; check parking position.
	Charging system	Check for function, e.g. start and stop of a charging process at all charger interfaces.
Wear parts	Replace, e.g. filter mats (only for active cooling).	
As required	Charging system	Clean the inside and outside of the housing.

11.2 Cleaning

The components inside the charging system need to be cleaned according to the assessment of an expert but this is not always necessary. Any necessary cleaning of the interior must only be carried out after consultation with the operator of the charging system. Cleaning may only be carried out by a properly and professionally instructed person and must never be carried out by a user.

Only materials and dry cleaning agents which are antistatic and do not damage the electrical or mechanical components may be used as cleaning agents for the interior. Only materials and agents that do not attack or damage the surface of the housing or any applied foiling or paintwork should be used as cleaning agents for the external housing. If chemical agents are used during cleaning, the work must be carried out outdoors or, if this is not possible, only in well-ventilated rooms.

 DANGER**Danger due to electric current**

Touching live parts will result in electric shock with serious injury or death.

- Only clean the charging system when it is switched off.
 - Do not clean the outer housing with water jets, e.g. with a hose or a high-pressure cleaner.
 - Do not clean the interior of the charging system with liquid cleaning agents.
 - Do not clean any plugs in the charging system.
-

12 Decommissioning, dismantling and disposal

The decommissioning and dismantling of the charging system may only be carried out by a qualified electrician. The national legal requirements and regulations must be observed.

DANGER

Danger due to electric current

Touching live parts will result in electric shock with serious injury or death.

- Work on electrical components may only be carried out by a qualified electrician and in accordance with electrical engineering rules.
- Ensure they are de-energised and take suitable protective measures.

1. Finish charging processes properly.
2. Disconnect the charging system from the power supply.
 - Activate using the internally installed safety elements such as MCB, RCD and any installed main switch.
 - Release the upstream fuse element of the charging system.

Dismantling may only be carried out after it has been established that no voltage is present and suitable protective measures have been taken.

12.1 Disposal

The unit contains materials that can be recycled. To protect the environment and human health, disposal must be carried out in accordance with the laws of the country and the existing take-back organisations.

- Observe the requirements of the WEEE Directive 2012/19/EU.
- Dispose of the unit accordingly only via the take-back organisation.
- Dispose of dismantled components only via the take-back organisation.

NOTE

Compleo charging systems as a whole do not contain SVHCs in a concentration of more than 0.1 % (w/w), related to the individual charging station. However, individual components may contain SVHCs in concentrations > 0.1 % (w/w).

- When the charging stations are used as intended, no SVHCs are released and there are no risks to humans or the environment.

NOTE

Incorrect or negligent disposal causes environmental pollution.

- If you have any questions about environmentally friendly disposal, ask your specialist dealer or the manufacturer for information.

13 Annexes

13.1 Housing dimensions

Base design (version 1):

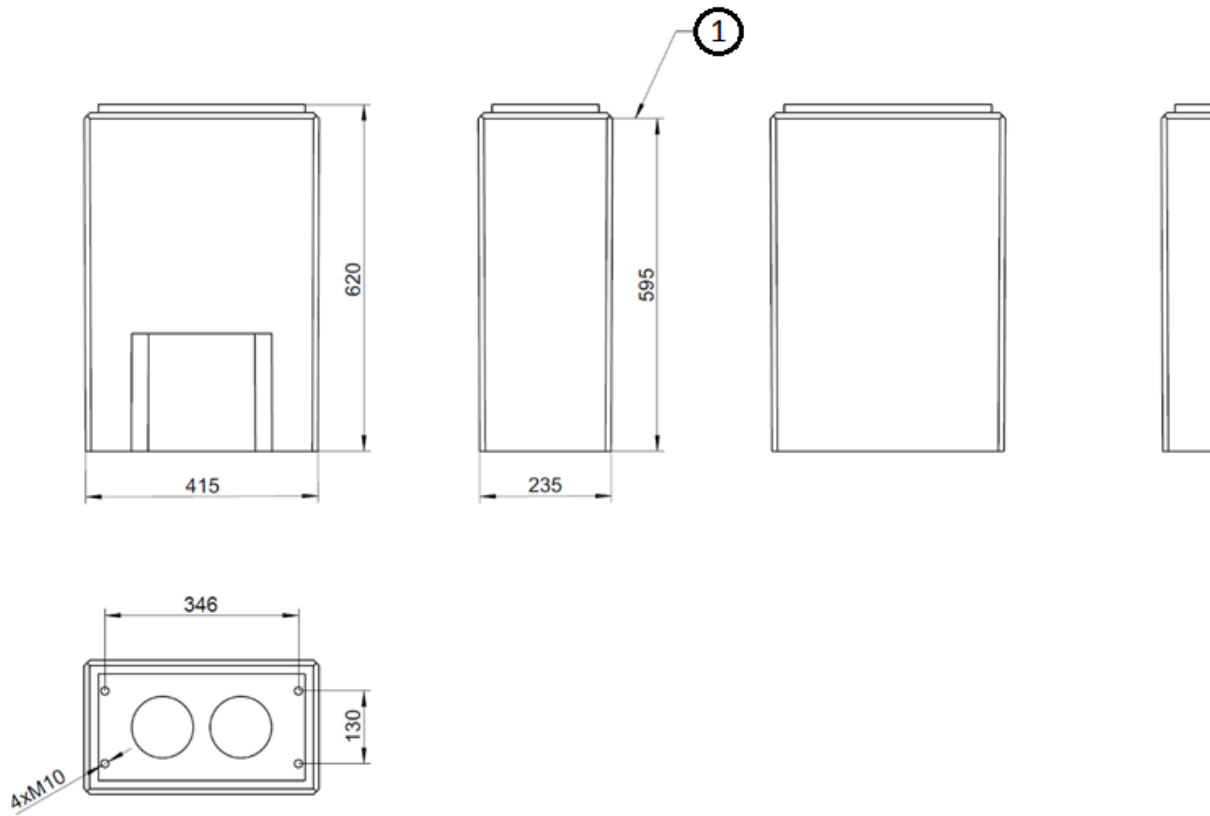

Base design (version 2):

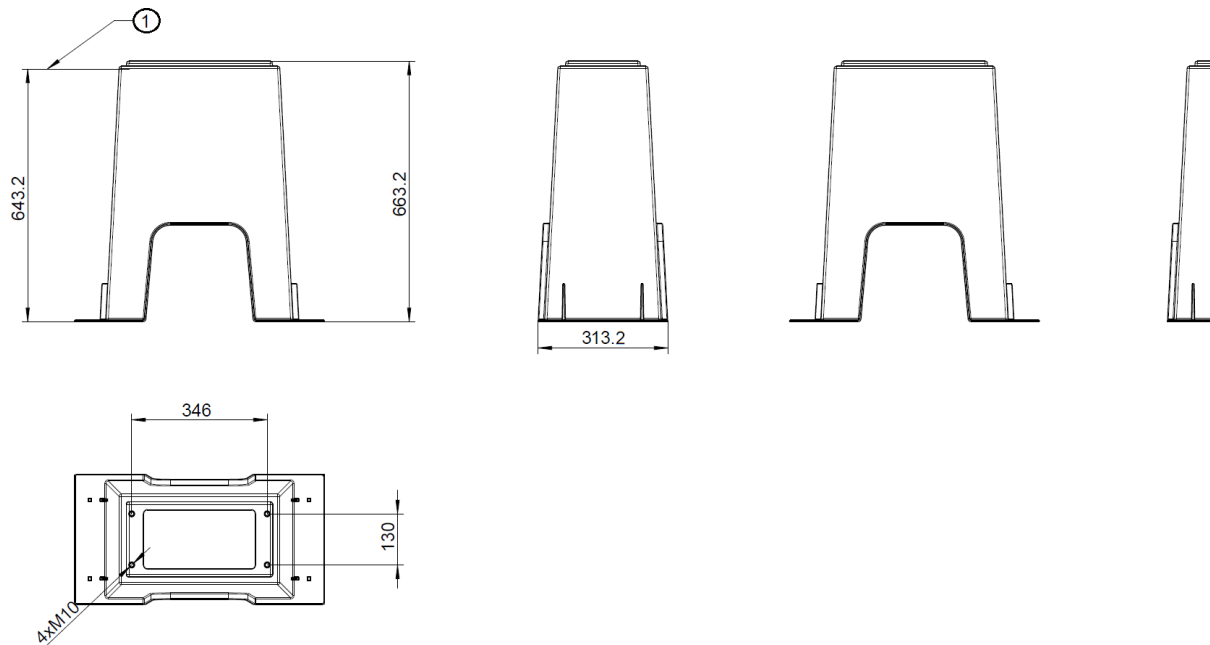

(1) = Ground level (lower edge of bevel)

Design drawing of the concrete base of the charging system

Annexes

Charging system design:

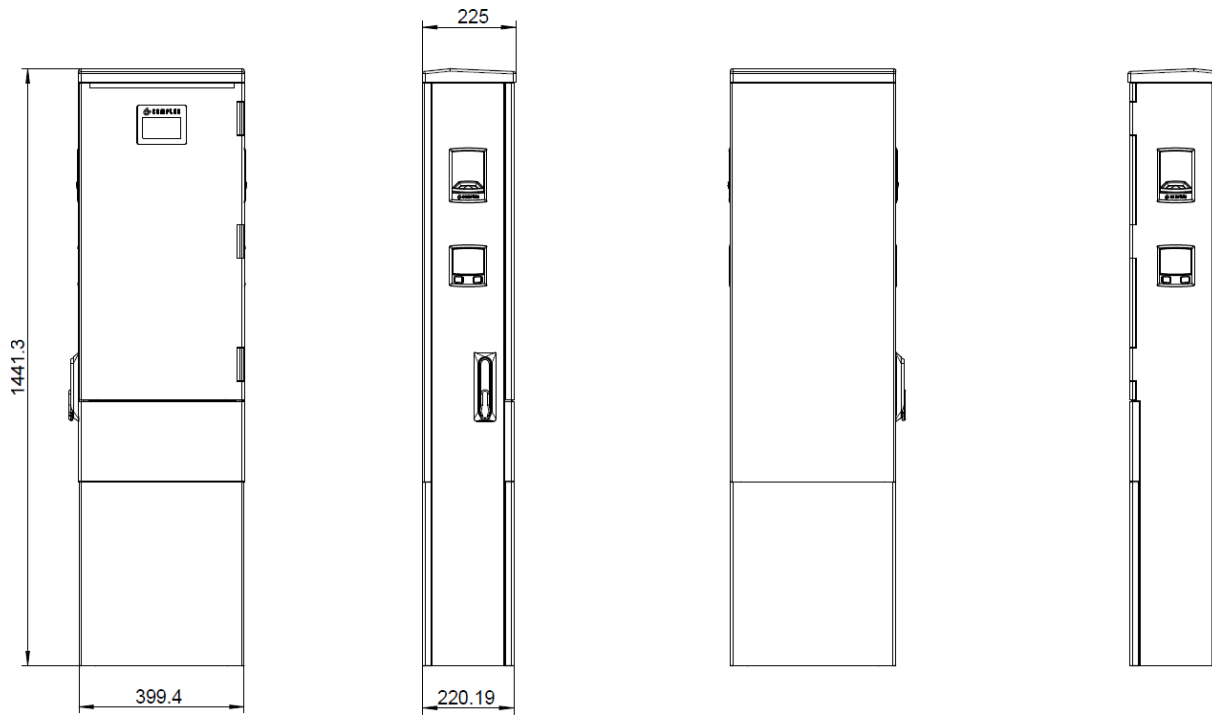

Design drawing of the compleo® Advanced BM charging system

Version 1

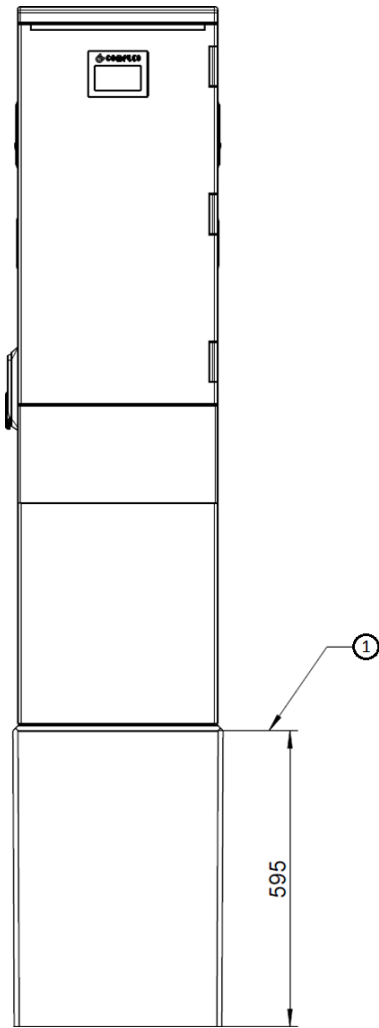

Version 2

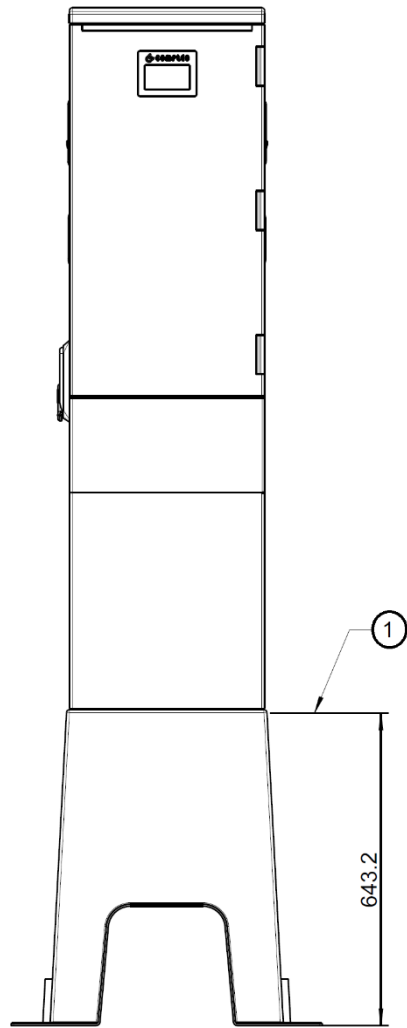

(1) = Ground level

Design drawing of the concrete base and the mounted compleo® Advanced BM charging system

13.2 Prüfprotokoll



Inbetriebnahme- und Prüfprotokoll für AC-Ladesysteme

Anwendbar für AC Ladesysteme

Betreiber der Anlage:

Firma/Name:

Straße:

PLZ/Stadt:

Telefonnummer:

Standort der Anlage:

Prüfendes Unternehmen:

Firma/Name:

Straße:

PLZ/Stadt:

Telefonnummer:

Datum:

Erstinbetriebnahme: in Anlehnung an DIN VDE 0100-600 (2017:06)

Wiederkehrende Prüfung: in Anlehnung an DIN VDE 0105-100 (2015:10)

1 Allgemeine Angaben

Vorinstallation durchgeführt durch Kunde	<input type="checkbox"/> ja	<input type="checkbox"/> nein
Dokumentation zur Vorinstallation vorhanden (Protokoll Vorinstallation)	<input type="checkbox"/> ja	<input type="checkbox"/> nein

Bezeichnung des Prüflings:				
Seriennummer:				
Netzform:	<input type="checkbox"/> TT	<input type="checkbox"/> TN-S	<input type="checkbox"/> TN-C	<input type="checkbox"/> TN-C-S
Lokale Erdung vorhanden	<input type="checkbox"/> ja	<input type="checkbox"/> nein		
Blitzschutzkonzept am Standort erkennbar/vorhanden	<input type="checkbox"/> ja	<input type="checkbox"/> nein	Betreiber auf Notwendigkeit hinweisen!	

1.1 Ausstattungabhängige Angaben

Bauteil	Nicht verbaut	Seriennummer	Zählerstand in kWh
Ladepunktzähler 1	<input type="checkbox"/>		
Ladepunktzähler 2	<input type="checkbox"/>		
Bauteil	Nicht verbaut	Typbezeichnung	Bemerkungen
Überspannungsschutz	<input type="checkbox"/>		
Überspannungsschutz	<input type="checkbox"/>		



2 Arbeiten vor Erstinbetriebnahme

INFO: Ablängen der Kabelisolierungen nach Installationsanweisung (bei Nichtbeachtung droht **BRANDGEFAHR**)

Überprüfung der Kabelverschraubungen (Drehmoment) und Zugprüfung an Leitungen im spannungsfreien Zustand erfolgt? Ja Nein

2.1 Verwendete Mess- und Prüfmittel

Hersteller	Bezeichnung	Seriennummer	Nächste Kalibrierung

3 Optische Prüfungen

Sichtprüfung außen	i.O.	n.i.O	Bemerkungen
Gehäusezustand	<input type="checkbox"/>	<input type="checkbox"/>	
Verschmutzung	<input type="checkbox"/>	<input type="checkbox"/>	
Displayscheibe Zähler/SAM	<input type="checkbox"/>	<input type="checkbox"/>	
Displayscheibe Steuerung	<input type="checkbox"/>	<input type="checkbox"/>	
Ladekabel AC (falls vorhanden)	<input type="checkbox"/>	<input type="checkbox"/>	Austausch bei Defekt zwingend erforderlich!

Sichtprüfung innen	i.O.	n.i.O	Bemerkungen
Bauteile (RCD, Schütz, MCB,...)	<input type="checkbox"/>	<input type="checkbox"/>	
Verkabelung	<input type="checkbox"/>	<input type="checkbox"/>	z.B. Kabelverschraubung
Verschmutzungsgrad allgemein	<input type="checkbox"/>	<input type="checkbox"/>	
Feuchtigkeit	<input type="checkbox"/>	<input type="checkbox"/>	
Korrosion	<input type="checkbox"/>	<input type="checkbox"/>	
Überspannungsschutz (falls vorh.)	<input type="checkbox"/>	<input type="checkbox"/>	Optische Anzeige = grün
Sockelfüller eingebracht	<input type="checkbox"/>	<input type="checkbox"/>	
Abdeckungen zu aktiven Teilen	<input type="checkbox"/>	<input type="checkbox"/>	

4 Messtechnische Überprüfung (1-mal jährlich durchzuführen)

Prüfung	Einzelmessungen	Grenzwert	Lade- punkt 1	Lade- punkt 2	Bemerkungen
Durchgängigkeit Schutzleiter	Schutzleiter	Niederohmig Empfehlung:<1Ω	MΩ	MΩ	Messung von Ladekabel/Ladesteckdose bis Einspeisung Ladesäule
Hauptpotentialausgleichschiene (falls vorhanden)	Erderanschluss	Niederohmig		Ω	Empfehlung: <1Ω:
Isolationswiderstand ohne Verbraucher (von Speisepunkt Ladesystem bis Ladestecker, bei fest angeschlagenem Kabel, bzw. Fahrzeugkupplung)	L1-PE	≥1,0MΩ	MΩ	MΩ	Bei Ladesystemen mit zwei Ladepunkten vor Messbeginn ein Ladepunkt durch Abschalten eines MCB freischalten und andere Seite messen, danach diese Prozedur auf anderer Seite wiederholen. (verbaute Zähler und RCD beeinflussen das Messergebnis)
	L2-PE		MΩ	MΩ	
	L3-PE		MΩ	MΩ	
	N-PE		MΩ	MΩ	
	L1-L2	≥1,0MΩ	MΩ	MΩ	
	L2-L3		MΩ	MΩ	
	L1-L3		MΩ	MΩ	
	L1-N		MΩ	MΩ	
L2-N	MΩ		MΩ		
L3-N	MΩ	MΩ			
LP1 Verdrahtung auf Rechtsdrehfeld	<input type="checkbox"/> i.O. <input type="checkbox"/> n.i.O.				
LP2 Verdrahtung auf Linksdrehfeld	<input type="checkbox"/> i.O. <input type="checkbox"/> n.i.O.				Linksdrehfeld an LP2 erlaubt!!!
Netzspannung	L1-N	230V +/-10%		V	
	L2-N			V	
	L3-N			V	
	L1-L2	400V +/-10%		V	
	L2-L3			V	
	L1-L3			V	
Rel. Spannungsfall (Ber. Mess.)	<input type="checkbox"/> i.O. <input type="checkbox"/> n.i.O.	max. 5% bis Speisepunkt			
Fehler- schleifen- impedanz Z _s	TN-Netz	L1-PE	$Z_s \leq \frac{U_0}{I_a}$ U ₀ =Nennwechselspannung I _a =Auslösestrom (MCB/RCD)	<input type="checkbox"/> i.O. <input type="checkbox"/> n.i.O.	<input type="checkbox"/> i.O. <input type="checkbox"/> n.i.O.
		L2-PE		<input type="checkbox"/> i.O. <input type="checkbox"/> n.i.O.	<input type="checkbox"/> i.O. <input type="checkbox"/> n.i.O.
		L3-PE		<input type="checkbox"/> i.O. <input type="checkbox"/> n.i.O.	<input type="checkbox"/> i.O. <input type="checkbox"/> n.i.O.
	TT-Netz	L1-PE	$Z_s \leq \frac{50V}{I_{\Delta N}}$ I _{ΔN} = Bemessungsdifferenzstrom in A des RCD	<input type="checkbox"/> i.O. <input type="checkbox"/> n.i.O.	<input type="checkbox"/> i.O. <input type="checkbox"/> n.i.O.
		L2-PE		<input type="checkbox"/> i.O. <input type="checkbox"/> n.i.O.	<input type="checkbox"/> i.O. <input type="checkbox"/> n.i.O.
		L3-PE		<input type="checkbox"/> i.O. <input type="checkbox"/> n.i.O.	<input type="checkbox"/> i.O. <input type="checkbox"/> n.i.O.
		N-PE		<input type="checkbox"/> i.O. <input type="checkbox"/> n.i.O.	<input type="checkbox"/> i.O. <input type="checkbox"/> n.i.O.
Fehlerstrom schutzzeit- richtung RCD	AC Fehlerstrom sinusförmig	Auslösestrom I _{ΔN} =30mA	>15 mA ≤30mA	mA	mA
		Auslösezeit 1x I _N	<300ms	ms	ms
		Auslösezeit 5x I _N	<40ms	ms	ms
	DC (6mA Sensor = pos. und neg. Flanke)	Auslösestrom I _{ΔN} =30mA	≤6mA bei 6mA Sensor ≤60mA bei RCD Typ B	Positive Flanke	mA
Negative Flanke				mA	mA



	RCD Typ B = ansteigender DC Fehlerstrom)	Auslösezeit	<10s bei 6mA < 0,3s bei Typ B	Positive Flanke Negative Flanke	s s	s s	
--	--	-------------	----------------------------------	------------------------------------	--------	--------	--

5 Funktionelle Prüfungen

Prüfung	Ladepunkt 1		Ladepunkt 2		Bemerkungen
	i.O.	n.i.O.	i.O.	n.i.O.	
Ladevorgang AC	<input type="checkbox"/>	<input type="checkbox"/>	<input type="checkbox"/>	<input type="checkbox"/>	
Schließmechanismus	<input type="checkbox"/>	<input type="checkbox"/>	<input type="checkbox"/>	<input type="checkbox"/>	
Funktion Prüftaste RCD	<input type="checkbox"/>	<input type="checkbox"/>	<input type="checkbox"/>	<input type="checkbox"/>	
Auslösung HRA	<input type="checkbox"/>	<input type="checkbox"/>	<input type="checkbox"/>	<input type="checkbox"/>	Ladesäule in StandBy → Schutz AC-Ladepunkt betätigen → RCD muss auslösen

6 Ergebnis:

Prüfergebnisse	Ja	Nein
Alle Prüfungen wurden durchgeführt	<input type="checkbox"/>	<input type="checkbox"/>
Mängel vorhanden	<input type="checkbox"/>	<input type="checkbox"/>
Mängel beseitigt	<input type="checkbox"/>	<input type="checkbox"/>
Prüfplakette angebracht	<input type="checkbox"/>	<input type="checkbox"/>

Bemerkungen:
Nächster Prüftermin am:
Ort, Datum:
Prüfer: Vor- und Nachname in Druckbuchstaben
Unterschrift:

13.3 EU Declaration of Conformity

Declaration of conformity:

EU-Konformitätserklärung

(DoC_CE_Duo_Rev0_20210419)

COMPLEO

Gegenstand der Erklärung

Produkt: **Konduktive Ladesysteme für Elektrofahrzeuge (Mode 3 Ladestation)**

Typenbezeichnung/	Advanced BM/GM/WM/PM SAM AC1	A11WX*YZ**.*
Produktnummer:	Highline BM/GM/WM/PM SAM AC1	A12WX*YZ**.*
	Advanced BM/GM/WM/PM SAM AC1	A21WX*YZ**.*
	Highline BM/GM/WM/PM SAM AC1	A22WX*YZ**.*
	Advanced BM/GM/WM/PM	A01WX*YZ**.*
	Highline BM/GM/WM/PM	A02WX*YZ**.*

Hersteller

Name: **Compleo Charging Solutions AG**

Adresse: **Oberste-Wilms-Straße 15a, 44309 Dortmund, Deutschland**

Die alleinige Verantwortung für die Ausstellung dieser Konformitätserklärung trägt der Hersteller.

Der oben beschriebene Gegenstand der Erklärung erfüllt die einschlägigen Harmonisierungsrechtsvorschriften der Union:

2014/53/EU (Funkanlagenrichtlinie) [OJ L 153, 22.5.2014, p. 62-106]

2011/65/EU (RoHS-Richtlinie) [OJ L 174, 1.7.2011, p. 88-110]

Angabe der einschlägigen harmonisierten Normen, die zugrunde gelegt wurden, oder Angabe der anderen technischen Spezifikationen, in Bezug auf die die Konformität erklärt wird:

EN 61851-1:2011; IEC TS 61439-1:2014

Zusatzangaben

Typenschlüssel:
*W= 0 oder 3 → 0 = Standard, 3 = Fleet; X= E oder F → E = Mini RFID Reader + LTE, F = Multi RFID Reader + LTE;
 Y= 2, 3, 5 oder 6 → abhängig von verbauter Ladeleitung (Typ); Z= 1,2,3,4,5 oder 6 → Länge der Ladeleitung
 * = ohne Einfluss auf Konformitätserklärung*

CE-Kennzeichnung angebracht am 27.05.2019.

Ort und Datum der Ausstellung

Dortmund, 2021-04-19

©2022 Compleo. All rights reserved.

This document may not be copied in whole or in part without written permission. All illustrations in this document serve as examples only and may differ from the delivered product. All information in this document is subject to change without notice and does not represent a commitment on the part of the manufacturer.

